

Za tehnično podporo ali pomoč pokličite
090-6009



Zebra LS1203 Product Reference Guide

Več informacij: <http://bit.ly/citalec-1203>

Vprašanja? Kontaktirajte naše strokovnjake



090-6009



servis@info-kod.si



<http://www.info-kod.si>

Ponedeljek – Petek od 9:00 do 15:00

LS1203

Product Reference Guide

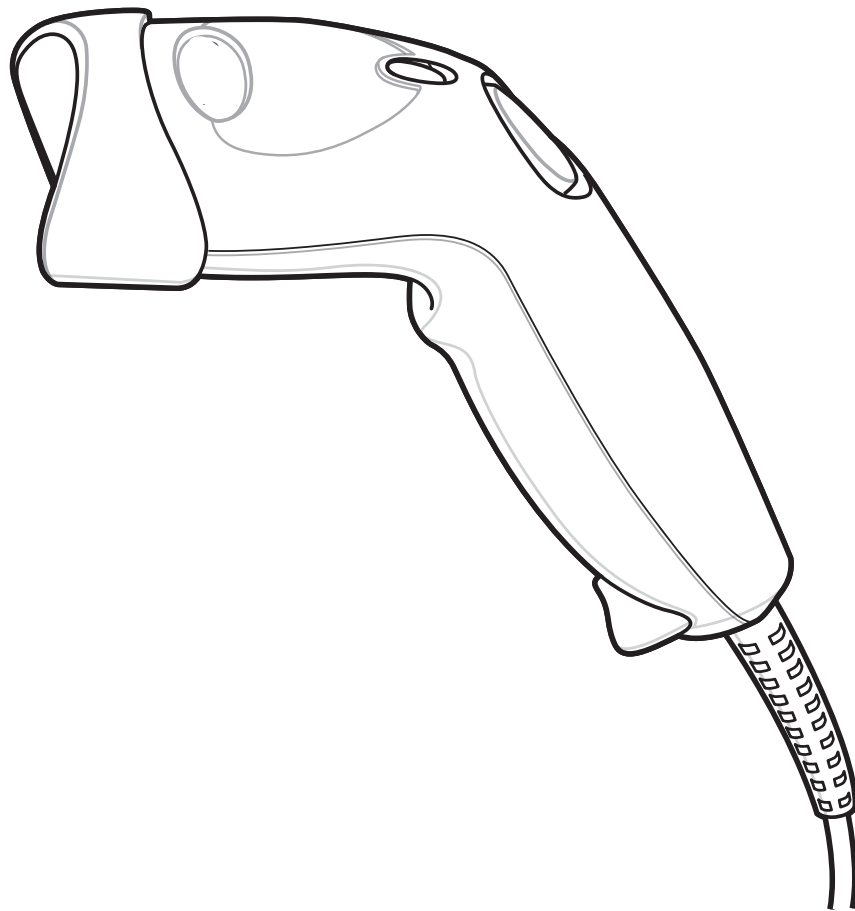

LS1203
Product Reference Guide

72E-73953-07

Revision A

April 2018

© 2018 ZIH Corp and/or its affiliates. All rights reserved. ZEBRA and the stylized Zebra head are trademarks of ZIH Corp, registered in many jurisdictions worldwide. All other trademarks are the property of their respective owners.

No part of this publication may be reproduced or used in any form, or by any electrical or mechanical means, without permission in writing from Zebra. This includes electronic or mechanical means, such as photocopying, recording, or information storage and retrieval systems. The material in this manual is subject to change without notice.

The software is provided strictly on an “as is” basis. All software, including firmware, furnished to the user is on a licensed basis. Zebra grants to the user a non-transferable and non-exclusive license to use each software or firmware program delivered hereunder (licensed program). Except as noted below, such license may not be assigned, sublicensed, or otherwise transferred by the user without prior written consent of Zebra. No right to copy a licensed program in whole or in part is granted, except as permitted under copyright law. The user shall not modify, merge, or incorporate any form or portion of a licensed program with other program material, create a derivative work from a licensed program, or use a licensed program in a network without written permission from Zebra. The user agrees to maintain Zebra’s copyright notice on the licensed programs delivered hereunder, and to include the same on any authorized copies it makes, in whole or in part. The user agrees not to decompile, disassemble, decode, or reverse engineer any licensed program delivered to the user or any portion thereof.

Zebra reserves the right to make changes to any software or product to improve reliability, function, or design.

Zebra does not assume any product liability arising out of, or in connection with, the application or use of any product, circuit, or application described herein.

No license is granted, either expressly or by implication, estoppel, or otherwise under any Zebra Technologies Corporation, intellectual property rights. An implied license only exists for equipment, circuits, and subsystems contained in Zebra products.

Zebra Technologies Corporation
Lincolnshire, IL U.S.A.
<http://www.zebra.com>

Warranty

For the complete Zebra hardware product warranty statement, go to:
<http://www.zebra.com/warranty>

Revision History

Changes to the original manual are listed below:

Change	Date	Description
-01 Rev A	1/2006	Initial release.
-02 Rev A	3/2006	Guide format updates. No content changes.
-03 Rev A	1/2008	Motorola rebranding, add hands free stand assembly instructions, add new UPC/EAN supplemental options and Bookland ISBN format option.

Change	Date	Description
-04 Rev A	8/2008	Add HD model, change UCC/EAN-128 code type name to GS1-128.
-05 Rev A	11/2012	Updated 123Scan ² chapter, URLs, ambient light tolerance, and service information; removed Patents, Regulatory specs, www.symbol.com/usb link, and references to the Symbol product.
-06 Rev A	2/2015	Zebra Re-Branding
-07 Rev A	4/2018	Changed GS1 DataBar-14 to GS1 DataBar Omnidirectional (formerly GS1 DataBar-14), updated 123Scan chapter, changed 123Scan ² to 123Scan, updated 123Scan URLs, changed MOD 10/MOD 11 to MOD 11/MOD 10, changed HID Keyboard Emulation to USB HID Keyboard, changed USB OPOS Handheld to OPOS (IBM Hand-held with Full Disable), added note in USB Interface chapter.

Table of Contents

Warranty	ii
Revision History	ii

About This Guide

Introduction	xi
Configurations.....	xi
Chapter Descriptions	xi
Notational Conventions.....	xii
Related Documents	xiii
Service Information.....	xiii

Chapter 1: Getting Started

Introduction	1-1
Unpacking	1-2
Setting Up the Scanner	1-2
Installing the Interface Cable	1-2
Removing the Interface Cable	1-3
Connecting Power (if required)	1-3
Assembling the Hands Free Stand	1-4
Configuring the Scanner	1-5

Chapter 2: Scanning

Introduction	2-1
Beeper Definitions	2-2
LED Definitions	2-3
Scanning	2-3
Aiming	2-4
Decode Zones	2-6
LS1203-SR Standard Range	2-6
LS1203-HD High Density	2-7

Chapter 3: Maintenance & Technical Specifications

Introduction	3-1
Maintenance	3-1
Troubleshooting	3-2
Technical Specifications	3-5
Scanner Signal Descriptions	3-6

Chapter 4: User Preferences

Introduction	4-1
Scanning Sequence Examples	4-1
Errors While Scanning	4-2
User Preferences Parameter Defaults	4-2
User Preferences	4-3
Default Parameters	4-3
Beeper Tone	4-4
Beeper Volume	4-4
Power Mode	4-5
Scanning Mode	4-5
Scan Line Width	4-6
Laser On Time	4-6
Beep After Good Decode	4-7
Transmit Code ID Character	4-7
Prefix/Suffix Values	4-8
Scan Data Transmission Format	4-8
FN1 Substitution Values	4-10
Transmit "No Read" Message	4-10

Chapter 5: Keyboard Wedge Interface

Introduction	5-1
Connecting a Keyboard Wedge Interface	5-2
Keyboard Wedge Parameter Defaults	5-3
Keyboard Wedge Host Parameters	5-4
Keyboard Wedge Host Types	5-4
Keyboard Wedge Country Types (Country Codes)	5-5
Ignore Unknown Characters	5-6
Keystroke Delay	5-7
Intra-Keystroke Delay	5-7
Alternate Numeric Keypad Emulation	5-8
Caps Lock On	5-8
Caps Lock Override	5-9
Convert Wedge Data	5-9
Function Key Mapping	5-10
FN1 Substitution	5-10
Send Make and Break	5-11
Keyboard Maps	5-11
ASCII Character Set for Keyboard Wedge	5-12

Chapter 6: RS-232 Interface

Introduction	6-1
Connecting an RS-232 Interface	6-2
RS-232 Parameter Defaults	6-3
RS-232 Host Parameters	6-4
RS-232 Host Types	6-6
Baud Rate	6-7
Parity	6-8
Stop Bit Select	6-9
Data Bits (ASCII Format)	6-9
Check Receive Errors	6-10
Hardware Handshaking	6-10
Software Handshaking	6-12
Host Serial Response Time-out	6-13
RTS Line State	6-14
Beep on <BEL>	6-14
Intercharacter Delay	6-15
Nixdorf Beep/LED Options	6-16
Ignore Unknown Characters	6-16
ASCII Character Set for RS-232	6-17

Chapter 7: USB Interface

Introduction	7-1
Connecting a USB Interface	7-2
USB Parameter Defaults	7-3
USB Host Parameters	7-4
USB Device Type	7-4
USB Country Keyboard Types (Country Codes)	7-5
USB Keystroke Delay	7-7
USB CAPS Lock Override	7-7
USB Ignore Unknown Characters	7-8
Emulate Keypad	7-8
USB Keyboard FN 1 Substitution	7-9
Function Key Mapping	7-9
Simulated Caps Lock	7-10
Convert Case	7-10
ASCII Character Set for USB	7-11

Chapter 8: Symbolologies

Introduction	8-1
Scanning Sequence Examples	8-1
Errors While Scanning	8-2
Symbology Parameter Defaults	8-2
UPC/EAN	8-5
Enable/Disable UPC-A/UPC-E	8-5
Enable/Disable UPC-E1	8-6
Enable/Disable EAN-13/EAN-8	8-7
Enable/Disable Bookland EAN	8-7

Decode UPC/EAN/JAN Supplementals	8-8
User-Programmable Supplementals	8-11
UPC/EAN/JAN Supplemental Redundancy	8-11
Transmit UPC-A Check Digit	8-12
Transmit UPC-E Check Digit	8-12
Transmit UPC-E1 Check Digit	8-13
UPC-A Preamble	8-13
UPC-E Preamble	8-14
UPC-E1 Preamble	8-15
Convert UPC-E to UPC-A	8-15
Convert UPC-E1 to UPC-A	8-16
EAN-8/JAN-8 Extend	8-16
Bookland ISBN Format	8-17
UCC Coupon Extended Code	8-18
Code 128	8-18
Enable/Disable Code 128	8-18
Enable/Disable GS1-128 (formerly UCC/EAN-128)	8-19
Enable/Disable ISBT 128	8-19
Code 39	8-20
Enable/Disable Code 39	8-20
Enable/Disable Trioptic Code 39	8-20
Convert Code 39 to Code 32	8-21
Code 32 Prefix	8-21
Set Lengths for Code 39	8-22
Code 39 Check Digit Verification	8-23
Transmit Code 39 Check Digit	8-23
Code 39 Full ASCII Conversion	8-24
Code 39 Buffering (Scan & Store)	8-24
Code 93	8-27
Enable/Disable Code 93	8-27
Set Lengths for Code 93	8-27
Code 11	8-28
Code 11	8-28
Set Lengths for Code 11	8-29
Code 11 Check Digit Verification	8-30
Transmit Code 11 Check Digits	8-30
Interleaved 2 of 5 (ITF)	8-31
Enable/Disable Interleaved 2 of 5	8-31
Set Lengths for Interleaved 2 of 5	8-31
I 2 of 5 Check Digit Verification	8-33
Transmit I 2 of 5 Check Digit	8-33
Convert I 2 of 5 to EAN-13	8-34
Discrete 2 of 5 (DTF)	8-34
Enable/Disable Discrete 2 of 5	8-34
Set Lengths for Discrete 2 of 5	8-35
Chinese 2 of 5	8-36
Enable/Disable Chinese 2 of 5	8-36
Codabar (NW - 7)	8-36
Enable/Disable Codabar	8-36
Set Lengths for Codabar	8-37

CLSI Editing	8-38
NOTIS Editing	8-38
MSI	8-39
Enable/Disable MSI	8-39
Set Lengths for MSI	8-39
MSI Check Digits	8-40
Transmit MSI Check Digit(s)	8-41
MSI Check Digit Algorithm	8-41
GS1 DataBar (formerly RSS, Reduced Space Symbology)	8-42
Convert GS1 DataBar to UPC/EAN	8-43
Symbology - Specific Security Levels	8-44
Redundancy Level	8-44
Security Level	8-46
Bi-directional Redundancy	8-47
Symbology - Intercharacter Gap	8-47

Chapter 9: 123Scan

Introduction	9-1
123Scan	9-1
Communication with 123Scan	9-2
123Scan Requirements	9-2
123Scan Information	9-2
Scanner SDK, Other Software Tools, and Videos	9-3
Advanced Data Formatting (ADF)	9-3

Appendix A: Standard Defaults

Appendix B: Programming Reference

Symbol Code Identifiers	B-1
AIM Code Identifiers	B-2

Appendix C: Sample Bar Codes

Code 39	C-1
UPC/EAN	C-1
UPC-A, 100%	C-1
EAN-13, 100%	C-1
Code 128	C-2
Interleaved 2 of 5	C-2
GS1 DataBar	C-3
GS1 DataBar Omnidirectional (formerly GS1 DataBar-14)	C-4

Appendix D: Numeric Bar Codes

Numeric Bar Codes	D-1
Cancel	D-3

Appendix E: ASCII Character Sets**Index**

About This Guide

Introduction

The *LS1203 Product Reference Guide* provides general instructions for setting up, operating, maintaining, and troubleshooting the LS1203 scanner.

Configurations

This guide includes the following configurations:

- LS1203-SR - Standard range scanning
- LS1203-HD - High density scanning

Chapter Descriptions

Topics covered in this guide are as follows:

- [Chapter 1, Getting Started](#) provides a product overview, unpacking instructions, and cable connection information.
- [Chapter 2, Scanning](#) describes parts of the scanner, beeper and LED definitions, and how to use the scanner in triggered and Auto-Scan™ modes.
- [Chapter 3, Maintenance & Technical Specifications](#) provides information on how to care for the scanner, troubleshooting, and technical specifications.
- [Chapter 4, User Preferences](#) includes programming bar codes for selecting user preference features for the scanner and commonly used bar codes to customize how the data is transmitted to the host device.
- [Chapter 5, Keyboard Wedge Interface](#) provides information for setting up the scanner for Keyboard Wedge operation.
- [Chapter 6, RS-232 Interface](#) provides information for setting up the scanner for RS-232 operation.
- [Chapter 7, USB Interface](#) provides information for setting up the scanner for USB operation.

- [Chapter 8, Symbologies](#) describes all symbology features and provides the programming bar codes necessary for selecting these features for the scanner.
- [Chapter 9, 123Scan](#) (PC based scanner configuration tool) provides the bar code that must be scanned to communicate with the 123Scan program.
- [Appendix A, Standard Defaults](#) provides a table of all host devices and miscellaneous scanner defaults.
- [Appendix B, Programming Reference](#) provides a table of AIM code identifiers, ASCII character conversions, and keyboard maps.
- [Appendix C, Sample Bar Codes](#) includes sample bar codes.
- [Appendix D, Numeric Bar Codes](#) includes the numeric bar codes to scan for parameters requiring specific numeric values.
- [Appendix E, ASCII Character Sets](#) provides ASCII character value tables.

Notational Conventions

- *Italics* are used to highlight chapters and sections in this and related documents
- **Bold** text is used to highlight the following:
 - Key names on a keypad.
- bullets (•) indicate:
 - Action items
 - Lists of alternatives
 - Lists of required steps that are not necessarily sequential
- Sequential lists (e.g., those that describe step-by-step procedures) appear as numbered lists.
- Throughout the programming bar code menus, asterisks (*) are used to denote default parameter settings.



* Indicates Default — **Baud Rate 9600** — Feature/Option



NOTE This symbol indicates something of special interest or importance to the reader. Failure to read the note will not result in physical harm to the reader, equipment or data.



CAUTION This symbol indicates that if this information is ignored, the possibility of data or material damage may occur.



WARNING! This symbol indicates that if this information is ignored the possibility that serious personal injury may occur.

Related Documents

The *LS1203 Quick Reference Guide* (p/n 72-73954-xx) provides general information to help the user get started with the scanner. It includes basic operation instructions and start up bar codes.

For the latest version of this guide and all guides, go to: <http://www.zebra.com/support>.

Service Information

If you have a problem using the equipment, contact your facility's technical or systems support. If there is a problem with the equipment, they will contact the Zebra Global Customer Support Center at: <http://www.zebra.com/support>.

When contacting Zebra support, please have the following information available:

- Serial number of the unit
- Model number or product name
- Software type and version number

Zebra responds to calls by e-mail, telephone or fax within the time limits set forth in service agreements. If your problem cannot be solved by Zebra support, you may need to return your equipment for servicing and will be given specific directions. Zebra is not responsible for any damages incurred during shipment if the approved shipping container is not used. Shipping the units improperly can possibly void the warranty.

If you purchased your business product from a Zebra business partner, please contact that business partner for support.

Chapter 1 Getting Started

Introduction

The scanner combines excellent scanning performance and advanced ergonomics to provide the best value in a lightweight laser scanner. Whether used in triggered mode or Auto-Scan™ mode, the scanner ensures comfort and ease of use for extended periods of time.

✓ **NOTE** The scanner does not support PDF417 bar codes and its variants.

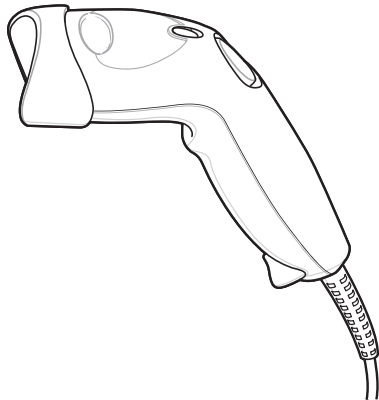

Figure 1-1 *LS1203 Scanner*

This scanner supports the following interfaces:

- Keyboard Wedge connection to a host. The host interprets scanned data as keystrokes. This interface supports the following international keyboards (for Windows® environment): North America, German, French, French Canadian, Spanish, Italian, Swedish, UK English, Portuguese-Brazilian, and Japanese.
- Standard RS-232 connection to a host. Scan bar code menus to set up proper communication of the scanner with the host.
- USB connection to a host. The scanner autodetects a USB host and defaults to the HID keyboard interface type. Select other USB interface types by scanning programming bar code menus. This interface supports the

following international keyboards (for Windows® environment): North America, German, French, French Canadian, Spanish, Italian, Swedish, UK English, Portuguese-Brazilian, and Japanese.

Unpacking

Remove the scanner from its packing and inspect it for damage. If the scanner was damaged in transit, call Zebra Support. See [page xiii](#) for contact information. **KEEP THE PACKING.** It is the approved shipping container and should be used if the equipment ever needs to be return for servicing.

Setting Up the Scanner

Installing the Interface Cable

To connect the interface cable:

1. Insert the interface cable's modular connector clip into the cable interface port on the bottom of the scanner handle. (See [Figure 1-2](#).)
2. Gently tug the cable to ensure the connector is properly secured.
3. Connect the other end of the interface cable to the host. (See the specific host chapter for information on host connections.)

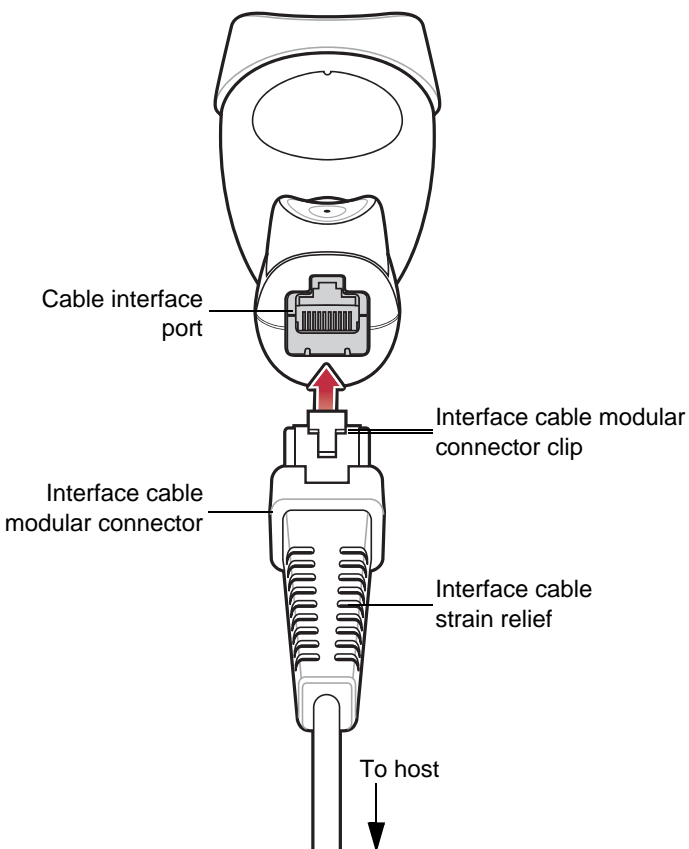

Figure 1-2 *Installing the Cable*

- ✓ **NOTE** Different cables are required for different hosts. The connectors illustrated in each host chapter are examples only. Actual connectors may be different than those illustrated, but the steps to connect the scanner remain the same.

Removing the Interface Cable

To remove the interface cable:

1. Unplug the installed cable modular connector by depressing the connector clip with the tip of a screwdriver, or a paper clip as shown in [Figure 1-3](#).

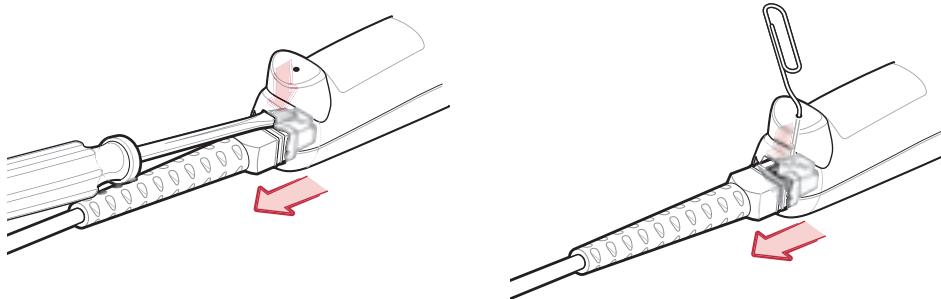

Figure 1-3 *Removing the Interface Cable*

2. Carefully slide out the cable.
3. Follow the steps for [Installing the Interface Cable on page 1-2](#) to connect a new cable.

Connecting Power (if required)

If the host does not provide power to the scanner, an external power connection to the scanner is required. To connect power:

1. Connect the interface cable to the bottom of the scanner, as described in [Installing the Interface Cable on page 1-2](#).
2. Connect the other end of the interface cable to the host (refer to the host manual to locate the correct port).
3. Plug the power supply into the power jack on the interface cable. Plug the other end of the power supply into an AC outlet.

Assembling the Hands Free Stand

1. Unscrew the wingnut from the bottom of the flexible neck.
2. Fit the bottom of the neck piece into the opening on the top of the stand base. When positioned correctly, the flat areas of the neck piece fit into place in the stand base opening.
3. Tighten the wingnut underneath the base to secure the cup and neck piece to the base.
4. Bend the neck to the desired position for scanning.

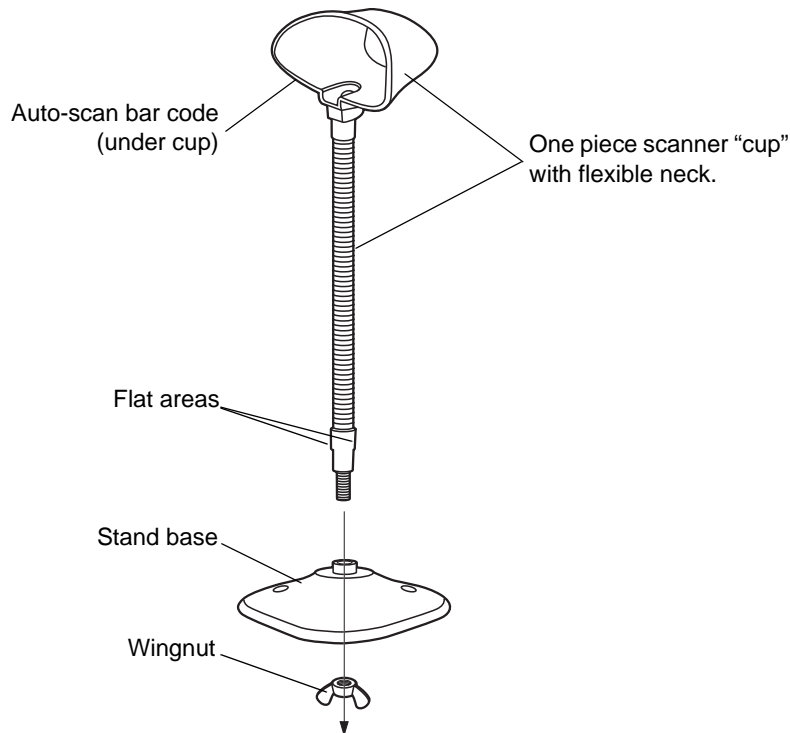

Figure 1-4 Hands Free Stand Parts

Set Auto-scan Mode

To enable hands free scanning, scan the **Auto-scan Mode** bar code on the back of the cup to set the scanner to auto-scan mode.

Mount Stand (Optional)

Attach the base of the scanner stand to a flat surface using two screws or double-sided tape.

✓ **NOTE** Screws and double-sided tape are not provided.

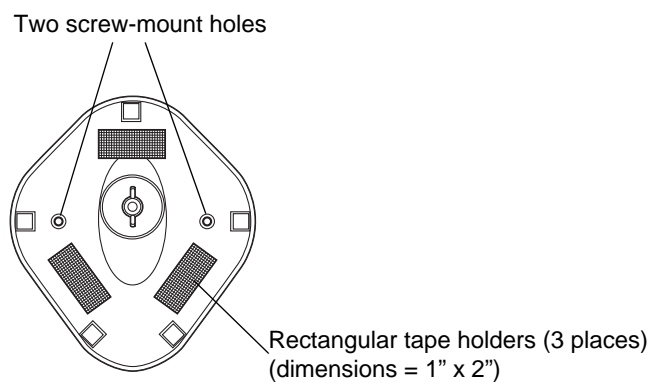

Figure 1-5 *Scanner Mount Stand*

Screw Mount

1. Position the assembled base on a flat surface.
2. Screw one #10 wood screw into each screw-mount hole until the base of the stand is secure.

Tape Mount

1. Peel the paper liner off one side of each piece of tape and place the sticky surface over each of the three rectangular tape holders.
2. Peel the paper liner off the exposed sides of each piece of tape and press the stand on a flat surface until it is secure.

Configuring the Scanner

To configure the scanner, use the bar codes included in this manual, or the 123Scan configuration program.

See [Chapter 4, User Preferences](#) and [Chapter 8, Symbolologies](#) for information about programming the scanner using bar code menus. Also see each host-specific chapter to set up a connection to a specific host type.

See [Chapter 9, 123Scan](#) to configure the scanner using this configuration program. A help file is available in the program.

Chapter 2 Scanning

Introduction

This chapter provides beeper and LED definitions, techniques involved in scanning bar codes, general instructions and tips about scanning, and decode zone diagrams.

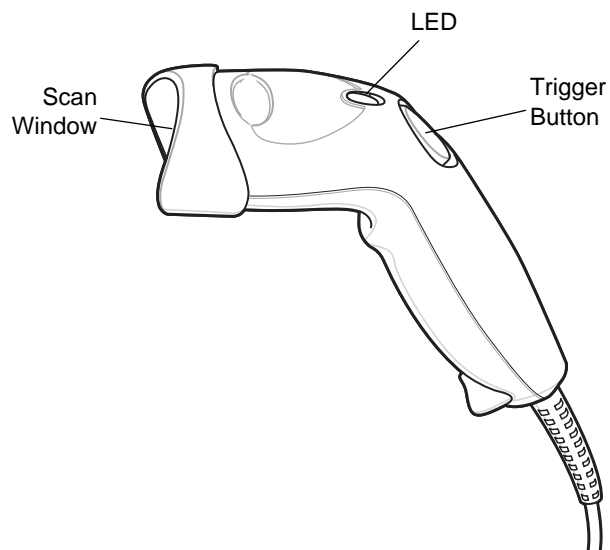

Figure 2-1 *Parts*

Beeper Definitions

The scanner issues different beep sequences and patterns to indicate status. [Table 2-1](#) defines beep sequences that occur during both normal scanning and while programming the scanner.

Table 2-1 *Beeper Definitions*

Beeper Sequence	Indication
Standard Use	
Low/medium/high beeps	Power up.
Short high beeps	A bar code symbol was decoded (if decode beeper is enabled).
4 long low beeps	A transmission error was detected in a scanned symbol. The data is ignored. This occurs if a unit is not properly configured. Check option setting.
5 low beeps	Conversion or format error.
Low/high/low beeps	Advanced Data Formatting (ADF) transmit error. (For information about ADF programming, refer to the Advanced Data Formatting Programmer Guide, p/n 72-69680-xx.)
High/high/high/low beeps	RS-232 receive error.
Parameter Menu Scanning	
Short high beeps	Correct entry scanned or correct menu sequence performed.
Low/high beeps	Input error, incorrect bar code or "Cancel" scanned, wrong entry, incorrect bar code programming sequence; remain in program mode.
High/low beeps	Keyboard parameter selected. Enter value using bar code keypad.
High/low/high/low beeps	Successful program exit with change in the parameter setting.
Low/high/low/high beeps	Out of host parameter storage space. Scan Default Parameters on page 4-3 .
Code 39 Buffering	
High/low beeps	New Code 39 data was entered into the buffer.
3 Beeps - long high beeps	Code 39 buffer is full.
Low/high/low beeps	The Code 39 buffer was erased or there was an attempt to clear or transmit an empty buffer.
Low/high beeps	A successful transmission of buffered data.

Table 2-1 *Beeper Definitions (Continued)*

Beeper Sequence	Indication
Host Specific	
USB only	
4 short high beeps	Scanner has not completed initialization. Wait several seconds and scan again.
Scanner gives a power-up beep after scanning a USB Device Type.	Communication with the bus must be established before the scanner can operate at the highest power level.
This power-up beep occurs more than once.	The USB bus may put the scanner in a state where power to the scanner is cycled on and off more than once. This is normal and usually happens when the host cold boots.
RS-232 only	
1 short high beep	A <BEL> character is received and Beep on <BEL> is enabled.

LED Definitions

In addition to beeper sequences, the scanner communicates with the user using a two-color LED display. Table 2-2 defines LED colors that display during scanning.

Table 2-2 *Standard LED Definitions*

LED	Indication
Off	No power is applied to the scanner, or the scanner is on and ready to scan.
Green	A bar code was successfully decoded.
Red	A data transmission error or scanner malfunction occurred.

Scanning

The scanner can operate in two scanning modes: triggered mode and Auto-Scan™ mode. In triggered mode the trigger button must be pressed to emit the scanner laser in order to a scan bar code. In Auto-Scan™ mode the scanner laser is in constant on state and no trigger button press is required to scan a bar code.

To toggle between scanning modes, scan **Triggered/Auto-Scan™** on [page 4-5](#).

- If the scanner is in triggered mode, scan **Triggered/Auto-Scan™** on [page 4-5](#) to switch to Auto-Scan™ mode.
- If the scanner is in Auto-Scan™ mode, scan **Triggered/Auto-Scan™** on [page 4-5](#) to switch to triggered mode.

✓ **NOTE** When the scanner is not used for an extended period of time in Auto-Scan™ mode, it enters sleep mode. To wake the scanner, press the trigger button.

To scan a bar code:

1. Install and program the scanner (see [Setting Up the Scanner on page 1-2](#)). For assistance, contact the local supplier or Zebra Support on [page xiii](#).
2. Ensure all connections are secure. (See the host chapter for the scanner.)
3. Aim the scanner at the bar code.
4. If the scanner is in triggered mode, press the trigger button. (In Auto-Scan™ mode, no trigger button press is required. The scanner laser is in constant on mode.)

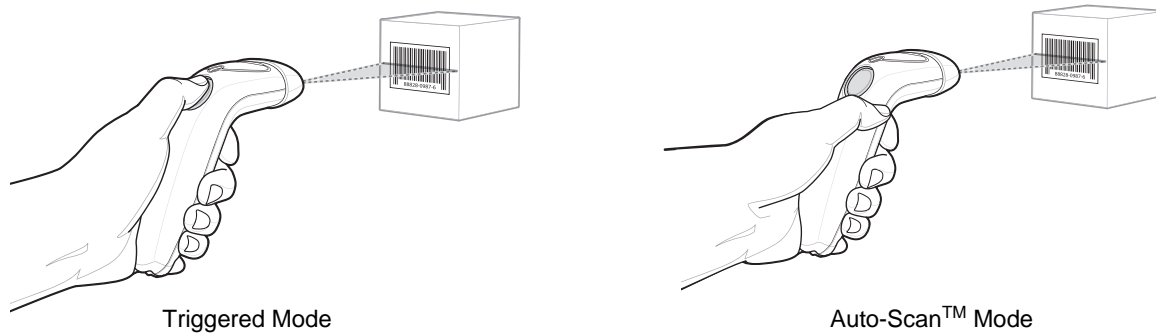

Figure 2-2 Scanning - Triggered and Auto-Scan™ Modes

5. Upon successful decode, the scanner beeps and the LED turns green. (For more information about beeper and LED definitions, see [Table 2-1](#) and [Table 2-2](#).)

✓ **NOTE** Scan line lengths vary depending on the scan line width selected (see [Scan Line Width on page 4-6](#)). A full scan line width is the default. The medium scan line width is useful for scanning menus or pick-lists.

Aiming

On a typical UPC 100% bar code symbol, hold the scanner between contact and 7 inches from the symbol (see [Decode Zones on page 2-6](#)). Ensure the scan line crosses every bar and space of the symbol.



Figure 2-3 Acceptable and Incorrect Aiming

The scan line is smaller when the scanner is closer to the symbol and larger when it is farther from the symbol. Scan symbols with smaller bars or elements (mil size) closer to the scanner and those with larger bars or elements (mil size) farther from the scanner.

Do not hold the scanner directly over the bar code. Laser light reflecting *directly* back into the scanner from the bar code is known as specular reflection. Specular reflection can make decoding difficult.

✓ **NOTE** Scan line lengths vary depending on the scan line width selected. A full scan line width is the default. The medium scan line width is useful for scanning menus or pick-lists.

For more information about scan line widths, see [page 4-6](#).

The scanner can be tilted up to 65° forward or back and achieve a successful decode (*Figure 2-4*). Simple practice quickly shows what tolerances to work within.

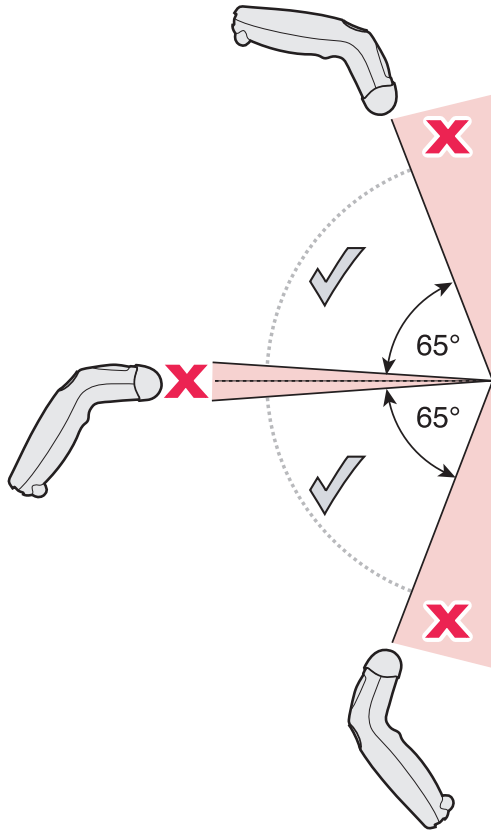
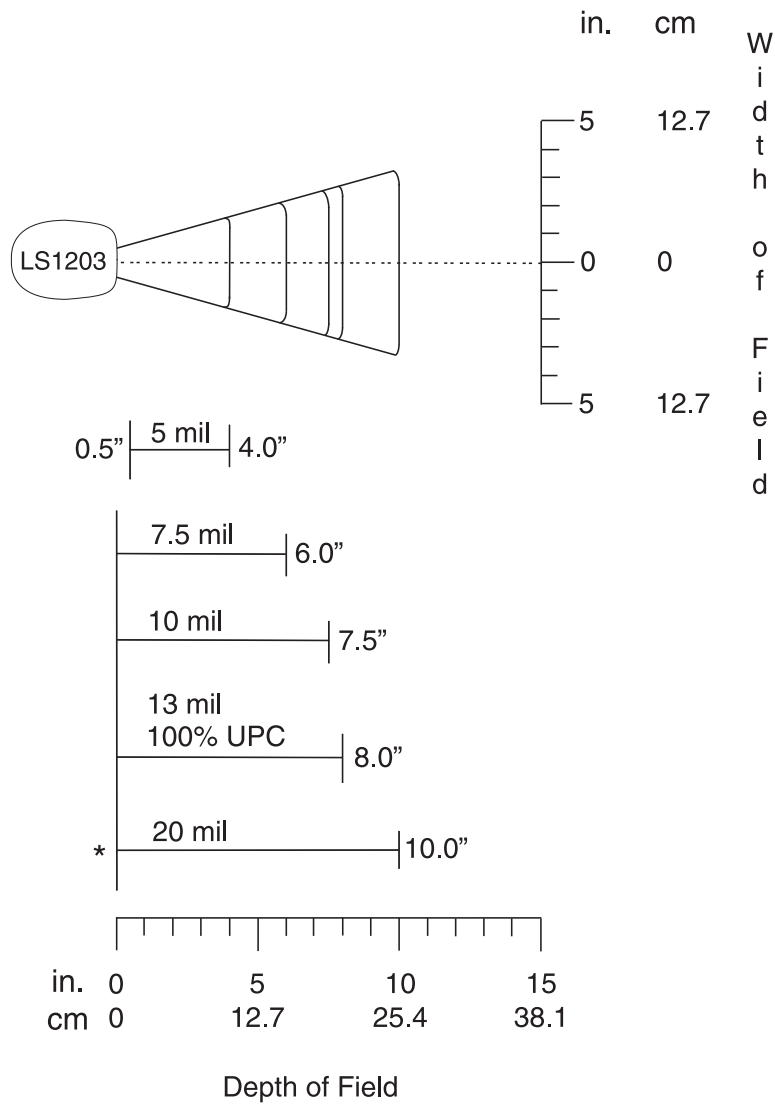

Figure 2-4 Maximum Tilt Angles and Dead Zone

Decode Zones

LS1203-SR Standard Range

Note: Typical performance at 73° F (23° C) on high quality symbols in normal room light.



*Minimum distance determined by symbol length and scan angle

Figure 2-5 LS1203-SR Standard Range Decode Zone

LS1203-HD High Density

Note: Typical performance at 73° F (23° C) on high quality symbols in normal room light.

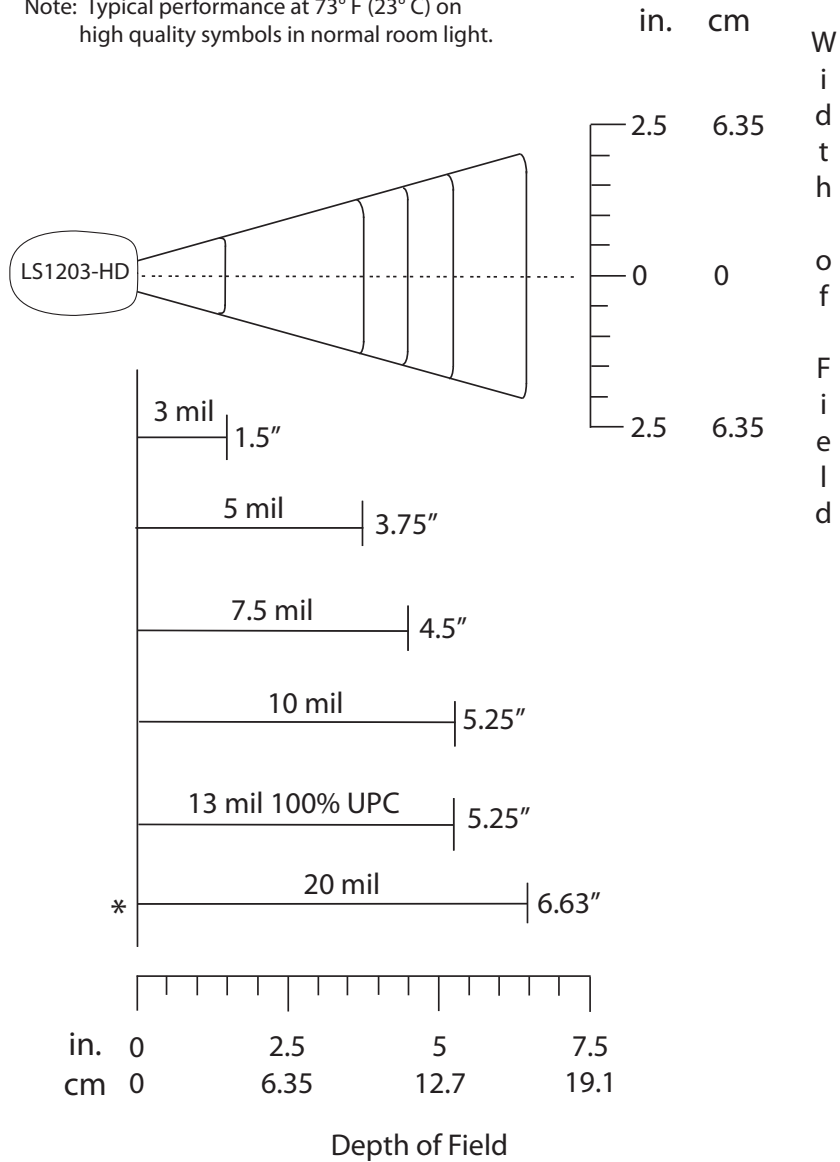

*Minimum distance determined by symbol length and scan angle

Figure 2-6 LS1203-HD High Density Decode Zone

Chapter 3 Maintenance & Technical Specifications

Introduction

This chapter provides suggested scanner maintenance, troubleshooting, technical specifications, and signal descriptions (pinouts).

Maintenance

Cleaning the exit window is the only maintenance required. A dirty window may affect scanning ability.

- Do not allow any abrasive material to touch the window
- Remove any dirt particles with a damp cloth
- Wipe the window using a tissue moistened with ammonia/water
- Do not spray water or other cleaning liquids directly into the window.

Troubleshooting

Table 3-1 *Troubleshooting*

Problem	Possible Causes	Possible Solutions
Beeper Indications (Also see Beeper Definitions on page 2-2)		
The scanner emits frequent beeps. (USB host interface only.)	The USB bus may put the scanner in a state where power to the scanner is cycled on and off more than once.	This is normal and usually happens when the host cold boots.
Scanner emits low/high/low beeps.	ADF transmit error.	Refer to the Advanced Data Formatting Programmer's Guide, p/n 72-69680-xx, for information about ADF programming.
	Invalid ADF rule is detected.	Refer to the Advanced Data Formatting Programmer's Guide, p/n 72-69680-xx, for information about ADF programming.
Scanner emits low/high beeps.	Input error, incorrect bar code or Cancel bar code was scanned.	Scan the correct numeric bar codes within range for the parameter programmed.
Scanner emits low/high/low beeps.	The Code 39 buffer was erased or there was an attempt to clear or transmit an empty buffer.	Normal when scanning the Code 39 Buffering Clear Buffer bar code or upon attempt to transmit an empty Code 39 buffer.
Scanner emits low/high/low/high beeps.	Out of host parameter storage space.	Scan Default Parameters on page 4-3 .
	Out of memory for ADF rules.	Reduce the number of ADF rules or the number of steps in the ADF rules.
Scanner emits high/low beeps.	The scanner is buffering Code 39 data.	Normal.
Scanner emits high/high/high/low beeps.	RS-232 receive error.	Normal during host reset. Otherwise, set the scanner's RS-232 parity to match the host setting.
Scanner emits four long low beeps.	A transmission error was detected in a scanned symbol. The data is ignored.	This occurs if a unit is not properly configured. Check option setting.
Scanner emits four short high beeps (USB only).	Scanner has not completed initialization.	Wait several seconds and scan again.
Scanner emits a short low/high/low/high beep sequence while it is being programmed.	Out of ADF parameter storage space.	Erase all rules and re-program with shorter rules.

Table 3-1 Troubleshooting (Continued)

Problem	Possible Causes	Possible Solutions
Decoding Bar Codes		
Scanner emits the laser, but does not decode the bar code.	Scanner is not programmed for the correct bar code type.	Program the scanner to read that type of bar code. See Chapter 8, Symbologies .
	Bar code symbol is unreadable.	Scan test symbols of the same bar code type to determine if the bar code is defaced.
	Distance between scanner and bar code is incorrect.	Move the scanner closer to or further from the bar code. See Decode Zones on page 2-6 .
	The scan line is not crossing every bar and space of the symbol.	Move the symbol until the scan line is within the acceptable aiming pattern. See Figure 2-3 on page 2-4 .
Scanner decodes bar code, but does not transmit the data to the host.	Scanner is not programmed for the correct host type.	Scan the appropriate host type programming bar code. See the chapter corresponding to the host type.
	Interface cable is loose.	Check for loose cable connection and re-connect cable.
Scanner emits five long low beep after a bar code is decoded.	Conversion or format error was detected. The scanner's conversion parameters are not properly configured.	Ensure the scanner's conversion parameters are properly configured.
	Conversion or format error was detected. An ADF rule was set up with characters that can't be sent for the host selected.	Change the ADF rule, or change to a host that can support the ADF rule.
	Conversion or format error was detected. A bar code was scanned with characters that can't be sent for that host.	Change the bar code, or change to a host that can support the bar code.

Table 3-1 *Troubleshooting (Continued)*

Problem	Possible Causes	Possible Solutions
Host Displays		
Host displays scanned data incorrectly.	Scanner is not programmed to work with the host.	Ensure the proper host is selected. Scan the appropriate host type programming bar code.
		For RS-232, set the scanner's communication parameters to match the host's settings.
		For a USB HID keyboard or Keyboard Wedge configuration, program the system for the correct keyboard type and language, and turn off the CAPS LOCK key.
		Program the proper editing options (e.g., ADF, UPC-E to UPC-A Conversion).
		Check the scanner's host type parameters or editing options.
Trigger		
Nothing happens when the trigger button is pressed.	No power to the scanner.	Check the system power. If the configuration requires a power supply, re-connect the power supply.
	Interface/power cables are loose.	Check for loose cable connections and re-connect cables.
	Incorrect host interface cable is used.	Verify that the correct host interface cable is used. If not, connect the correct host interface cable.

✓ **NOTE** If after performing these checks the symbol still does not scan, contact the distributor or Zebra. See [page xiii](#) for contact information.

Technical Specifications

Table 3-2 *Technical Specifications*

Item	Description
Physical Characteristics	
Dimensions	2.4 in. H x 7.1 in. L x 2.4 in. W (6.2 cm H x 18 cm L x 6 cm W)
Weight (without cable)	Approximately 4.3 oz. (122 g)
Voltage & Current	5 +/-10%VDC @ 100 mA (Stand by: <35 mA)
Color	Cash Register White or Twilight Black
Performance Characteristics	
Light Source (Laser)	650nm laser diode
Scan Rate	100 scans per second
Roll (Tilt) Tolerance	± 30° from normal
Pitch Tolerance	± 65°
Skew (Yaw) Tolerance	± 60°
Typical Working Distance	13 mil (100% UPC/EAN): 0 to 7 in. (17.78 cm) 5 mil (Code 39): 2.5 to 4.0 in. (6.35 cm to 10.16 cm) (See Decode Zones on page 2-6.)
Print Contrast Minimum	30% minimum reflectance
Decode Capability	UPC/EAN, UPC/EAN with Supplementals, GS1-128, Code 39, Code 39 Full ASCII, Code 39 TriOptic, Code 128, Code 128 Full ASCII, Codabar, Interleaved 2 of 5, Discrete 2 of 5, Code 93, MSI, Code 11, IATA, GS1 DataBar variants, Chinese 2 of 5
Interfaces Supported	RS-232; Keyboard Wedge; USB
User Environment	
Operating Temperature	32° to 122° F (0° to 50° C)
Storage Temperature	-40° to 158° F (-40° to 70° C)
Humidity	5% to 95% relative humidity, non-condensing
Drop Specifications	Withstands multiple 5 ft./1.524 m drops to concrete.
Ambient Light Tolerance	Tolerant to typical artificial indoor and natural outdoor (direct sunlight) lighting conditions. Fluorescent, Incandescent, Mercury Vapor, Sodium Vapor, LED: 450 Ft Candles (4,844 Lux) Sunlight: 8000 Ft Candles (86,111 Lux) Note: LED lighting with high AC ripple content can impact scanning performance.

Table 3-2 *Technical Specifications (Continued)*

Item	Description
Beeper Volume	User-selectable: three levels
Beeper Tone	User-selectable: three tones
Electrostatic Discharge	Conforms to 15 kV air discharge and 8 kV of contact discharge.

Scanner Signal Descriptions

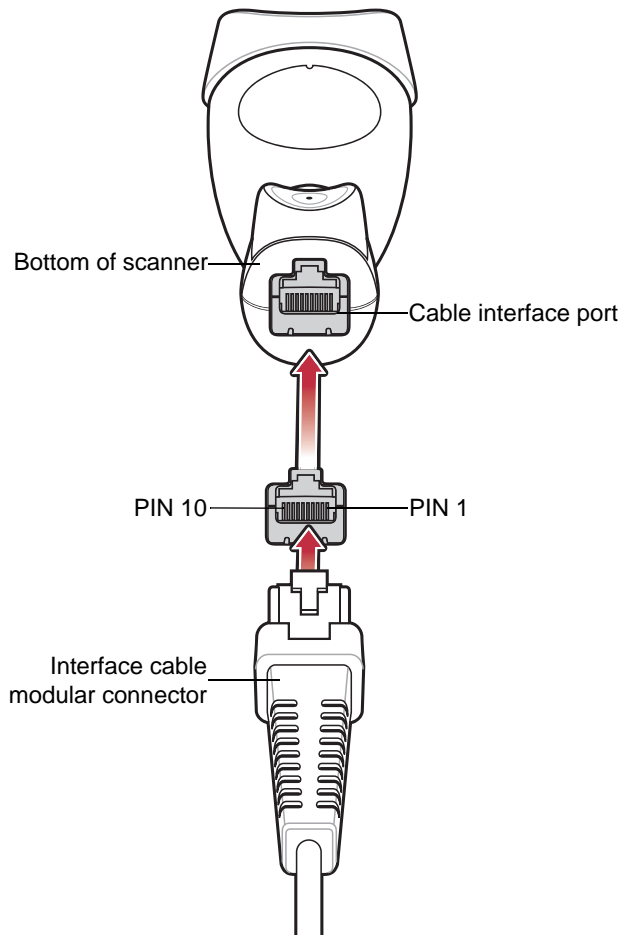

Figure 3-1 *Scanner Cable Pin-outs*

The signal descriptions in [Table 3-3](#) apply to the connector on the scanner and are for reference only.

Table 3-3 *Scanner Signal Pin-outs*

Pin	RS-232	Keyboard Wedge	USB
1	Reserved	Reserved	Jump to Pin 6
2	Power	Power	Power
3	Ground	Ground	Ground
4	TxD	KeyClock	Reserved
5	RxD	TermData	D +
6	RTS	KeyData	Jump to Pin 1
7	CTS	TermClock	D -
8	Reserved	Reserved	Reserved
9	n/a	n/a	n/a
10	n/a	n/a	n/a

Chapter 4 User Preferences

Introduction

If desired, program the scanner to perform various functions, or activate different features. If preferred, the 123Scan configuration utility is also available for programming the scanner (see [Chapter 9, 123Scan](#)). This chapter describes each user preference feature and provides the programming bar codes necessary for selecting these features.

The scanner ships with the settings shown in the [User Preferences on page 4-2](#) (also see [Appendix A, Standard Defaults](#) for all host defaults). If the default values suit requirements, programming may not be necessary.

To set feature values, scan a single bar code or a short bar code sequence. The settings are stored in non-volatile memory and are preserved even when the scanner is powered down.

If not using a USB cable, select a host type (see each host chapter for specific host information) after the power-up beeps sound. This is only necessary upon the first power-up when connected to a new host.

To return all features to their default values, see [User Preferences on page 4-2](#). Throughout the programming bar code menus, default values are indicated with asterisks (*).



* Indicates Default — *High Frequency — Feature/Option

Scanning Sequence Examples

In most cases, scanning one bar code sets the parameter value. For example, to set the beeper tone to high, scan the **High Frequency** (beeper tone) bar code listed under [Beeper Tone on page 4-4](#). The scanner issues a fast warble beep and the LED turns green, signifying a successful parameter entry.

Other parameters, such as **Serial Response Time-Out** or **Data Transmission Formats**, require scanning several bar codes. See these parameter descriptions for this procedure.

Errors While Scanning

Unless otherwise specified, when an error is made during a scanning sequence, just re-scan the correct parameter.

User Preferences Parameter Defaults

Table 4-1 lists the defaults for user preferences parameters. To change any option, scan the appropriate bar code(s) provided in the User Preferences section beginning on [page 4-3](#).

✓ **NOTE** See [Appendix A, Standard Defaults](#) for all user preferences, hosts and symbologies default parameters.

Table 4-1 *User Preferences*

Parameter	Default	Page Number
User Preferences		
Beeper Tone	Medium	4-4
Beeper Volume	High	4-4
Power Mode	Continuous On	4-5
Scanning Mode	Triggered	4-5
Scan Line Width	Full Width	4-6
Laser On Time	3.0 Sec	4-6
Beep After Good Decode	Enable	4-7
Transmit Code ID Character	None	4-7
Prefix Value	7013 <CR><LF>	4-8
Suffix Value	7013 <CR><LF>	4-8
Scan Data Transmission Format	Data as is	4-8
FN1 Substitution Values	Set	4-10
Transmit "No Read" Message	Disable	4-10

User Preferences

Default Parameters

The scanner can be reset to two types of defaults: factory defaults or custom defaults. Scan the appropriate bar code below to reset the scanner to its default settings and/or set the scanner's current settings as the custom default.

- **Restore Defaults** - Resets all default parameters as follows:
 - If custom default values were configured (see **Write to Custom Defaults**), the custom default values are set for all parameters each time the **Restore Defaults** bar code below is scanned.
 - If no custom default values were configured, the factory default values are set for all parameters each time the **Restore Defaults** bar code below is scanned. (For factory default values, see [Appendix A, Standard Defaults.](#))
- **Set Factory Defaults** - Scan the **Set Factory Defaults** bar code below to eliminate all custom default values and set the scanner to factory default values. (For factory default values, see [Appendix A, Standard Defaults.](#))
- **Write to Custom Defaults** - Custom default parameters can be configured to set unique default values for all parameters. After changing all parameters to the desired default values, scan the **Write to Custom Defaults** bar code below to configure custom defaults.



*Restore Defaults



Set Factory Defaults



Write to Custom Defaults

Beeper Tone

To select a decode beep frequency (tone), scan the **Low Frequency**, **Medium Frequency**, or **High Frequency** bar code.

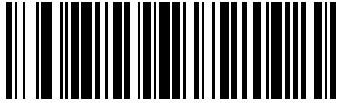

Low Frequency

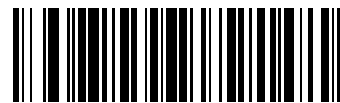

***Medium Frequency
(Optimum Settings)**



High Frequency

Beeper Volume

To select a beeper volume, scan the **Low Volume**, **Medium Volume**, or **High Volume** bar code.



Low Volume



Medium Volume



***High Volume**

Power Mode

This parameter determines whether or not power remains on after a decode attempt. When in reduced power mode, the scanner enters low power consumption mode after each decode. When in continuous power mode, power remains on after each decode.



*Continuous On



Reduced Power Mode

Scanning Mode

This parameter determines whether or not the scanner is in triggered mode or Auto-Scan™ mode. In triggered scanning mode, the scanner trigger button must be pressed to decode each scanned bar code. In Auto-Scan™ scanning mode, the scanner laser is in constant on state and no trigger button press is required to scan a bar code.

If the scanner is in triggered mode, scan **Triggered/Auto-Scan™** to switch to Auto-Scan™ mode. If the scanner is in Auto-Scan™ mode, scan **Triggered/Auto-Scan™** to switch to triggered mode.

- ✓ **NOTE** When the scanner is not used for an extended period of time in Auto-Scan™ mode, it enters sleep mode. To wake the scanner, press the trigger button.



*Triggered/Auto-Scan™ Mode

Scan Line Width

Scan a bar code below to set the scan line width.

✓ **NOTE** This feature applies to triggered mode only.



*Full Width



Medium Width

Laser On Time

This parameter sets the maximum time that decode processing continues during a scan attempt. It is programmable in 0.1 second increments from 0.5 to 9.9 seconds. The default Laser On Time is 3.0 seconds.

To set a Laser On Time, scan the bar code below. Next, scan two numeric bar codes in [Appendix D, Numeric Bar Codes](#) that correspond to the desired on time. Single digit numbers must have a leading zero. For example, to set an On Time of 0.5 seconds, scan the bar code below, then scan the “0” and “5” bar codes. If an error is made, or the selection needs to be changed, scan **Cancel** on [page D-3](#).



Laser On Time

Beep After Good Decode

Scan a bar code below to select whether or not the scanner beeps after a good decode. If **Do Not Beep After Good Decode** is selected, the beeper still operates during parameter menu scanning and indicates error conditions.



***Beep After Good Decode
(Enable)**

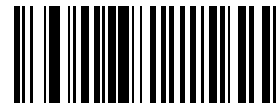

**Do Not Beep After Good Decode
(Disable)**

Transmit Code ID Character

A Code ID character identifies the code type of a scanned bar code. This may be useful when the scanner is decoding more than one code type. In addition to any single character prefix already selected, the Code ID character is inserted between the prefix and the decoded symbol.

Select no Code ID character, a Symbol Code ID character, or an AIM Code ID character. For Code ID Characters, see [Symbol Code Characters on page B-1](#) and [Aim Code Characters on page B-2](#).

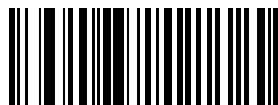

Symbol Code ID Character



AIM Code ID Character



***None**

Prefix/Suffix Values

A prefix and/or suffix can be appended to scan data for use in data editing.

To set a value for a prefix or suffix:

1. Change the scan data format by scanning the appropriate [Scan Data Transmission Format on page 4-8](#).
2. Scan the appropriate prefix/suffix bar code on [page 4-8](#).
3. Scan a four-digit number (i.e., four bar codes from [Appendix D, Numeric Bar Codes](#)) that corresponds to that value.

✓ **NOTE** When using host commands to set the prefix or suffix, set the key category parameter to 1, then set the 3-digit decimal value. See [Table E-1 on page E-1](#) for the four-digit codes.

4. To correct an error or change a selection, scan **Cancel** on [page D-3](#).

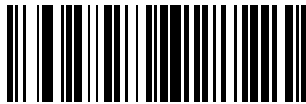

Scan Prefix

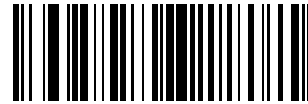

Scan Suffix

Scan Data Transmission Format

To change the scan data format, scan **Scan Options** and one of the following four bar codes corresponding to the desired format:

- Data As Is
- <DATA> <SUFFIX>
- <PREFIX> <DATA>
- <PREFIX> <DATA> <SUFFIX>.

Scan **Enter** on [page 4-9](#) to complete the change. To set values for the prefix and/or suffix, see [Prefix/Suffix Values on page 4-8](#). Scan **Data Format Cancel** on [page 4-9](#) to cancel the change.

If a carriage return/enter is required after each scanned bar code, scan the following bar codes in order:

1. **Scan Options**
2. <DATA> <SUFFIX>
3. **Enter** (on [page 4-9](#)).

Scan Data Transmission Format (continued)



Scan Options



*Data As Is

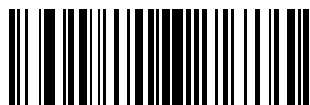

<DATA> <SUFFIX>



<PREFIX> <DATA>

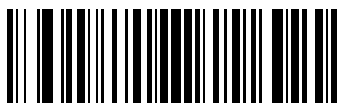

<PREFIX> <DATA> <SUFFIX>



Enter



Data Format Cancel

FN1 Substitution Values

The Wedge and USB HID Keyboard hosts support an FN1 substitution feature. When enabled any FN1 character (0x1b) in an EAN128 bar code is substituted with a value. This value defaults to 7013 (Enter Key).

To select an FN1 substitution value via bar code menus:

1. Scan the bar code below.

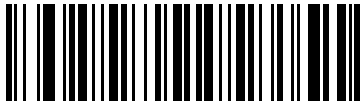

***Set FN1 Substitution Value**

2. Look up the keystroke desired for FN1 Substitution in the [ASCII Value - Code 39 Encode - Keystroke on page E-1](#) for the currently installed host interface.
3. Enter the 4-digit substitution value by scanning each digit in [Appendix D, Numeric Bar Codes](#).

To correct an error or change the selection, scan **Cancel**.

To enable FN1 substitution for keyboard wedge, scan the **Enable FN1 Substitution** bar code on [page 5-10](#).

To enable FN1 Substitution for USB HID keyboard, scan the **Enable FN1 Substitution** bar code on [page 7-9](#).

Transmit “No Read” Message

Scan a bar code below to select whether or not to transmit a No Read message. When enabled, the characters NR are transmitted when a bar code is not decoded. When disabled, if a symbol does not decode, nothing is sent to the host.



Enable No Read



***Disable No Read**

Chapter 5 Keyboard Wedge Interface

Introduction

This chapter describes how to set up a Keyboard Wedge interface with the scanner. With this interface, the scanner is connected between the keyboard and host computer, and translates bar code data into keystrokes. The host computer accepts the keystrokes as if they originated from the keyboard. This mode adds bar code reading functionality to a system designed for manual keyboard input. Keyboard keystrokes are simply passed through.

Throughout the programming bar code menus, default values are indicated with asterisks (*).



* Indicates Default — ***North American** — Feature/Option

Connecting a Keyboard Wedge Interface

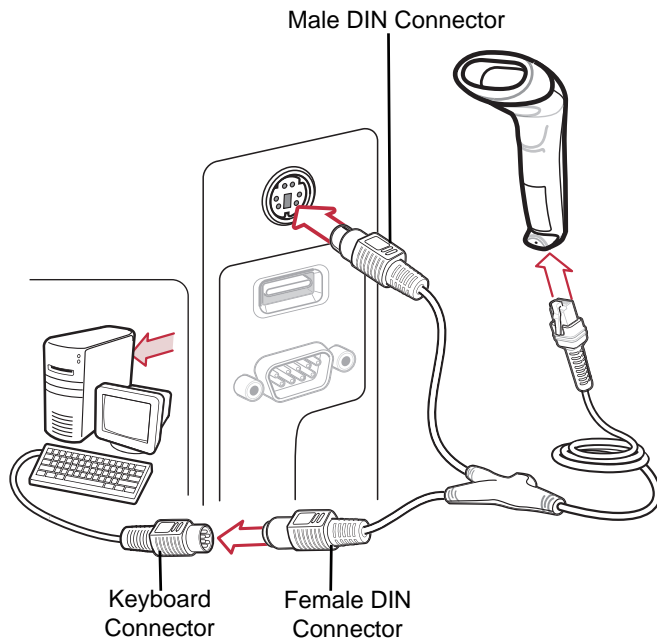

Figure 5-1 Keyboard Wedge Connection with Y-cable

To connect the Keyboard Wedge interface Y-cable:

✓ **NOTE** Interface cables vary depending on configuration. The connectors illustrated in [Figure 5-1](#) are examples only. The connectors may be different than those illustrated, but the steps to connect the scanner remain the same.

1. Turn off the host and unplug the keyboard connector.
2. Attach the modular connector of the Y-cable to the cable interface port on the scanner. (See [Installing the Interface Cable on page 1-2.](#))
3. Connect the round male DIN host connector of the Y-cable to the keyboard port on the host device.
4. Connect the round female DIN keyboard connector of the Y-cable to the keyboard connector.
5. If needed, attach the optional power supply to the connector in the middle of the Y-cable.
6. Ensure that all connections are secure.
7. Turn on the host system.
8. Select the Keyboard Wedge host type by scanning the appropriate bar code from [Keyboard Wedge Host Parameters on page 5-4.](#)
9. To modify any other parameter options, scan the appropriate bar codes in this chapter.

Keyboard Wedge Parameter Defaults

✓ **NOTE** See [Appendix A, Standard Defaults](#) for all user preferences, hosts, symbologies, and miscellaneous default parameters.

[Table 5-1](#) lists the defaults for Keyboard Wedge host parameters. To change any option, scan the appropriate bar code(s) in the Keyboard Wedge Host Parameters section beginning on [page 5-4](#).

Table 5-1 *Keyboard Wedge Defaults*

Parameter	Default	Page Number
Keyboard Wedge Host Parameters		
Keyboard Wedge Host Type	IBM PC/AT& IBM PC Compatibles ¹	5-4
Country Types (Country Codes)	North American	5-5
Ignore Unknown Characters	Send	5-6
Keystroke Delay	No Delay	5-7
Intra-Keystroke Delay	Disable	5-7
Alternate Numeric Keypad Emulation	Disable	5-8
Caps Lock On	Disable	5-8
Caps Lock Override	Disable	5-9
Convert Wedge Data	No Convert	5-9
Function Key Mapping	Disable	5-10
FN1 Substitution	Disable	5-10
Send and Make Break	Send	5-11

¹User selection is required to configure this interface and this is the most common selection.

Keyboard Wedge Host Parameters

Keyboard Wedge Host Types

Select the Keyboard Wedge host by scanning one of the bar codes below.

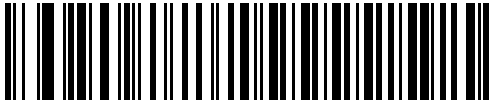

IBM PC/AT & IBM PC Compatibles¹



IBM AT Notebook

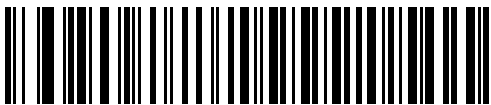

NCR 7052



IBM PS/2 (Model 30)

✓ **NOTE** ¹User selection is required to configure this interface and this is the most common selection.

Keyboard Wedge Country Types (Country Codes)

Scan the bar code corresponding to the keyboard type. If the keyboard type is not listed, see [Alternate Numeric Keypad Emulation on page 5-8](#).

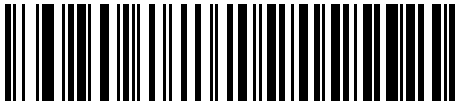

***North American**

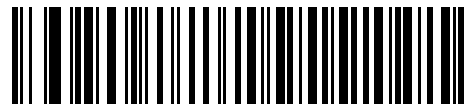

German Windows

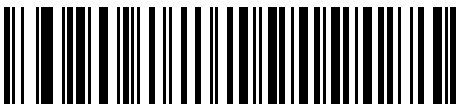

French Windows



French Canadian Windows 95/98

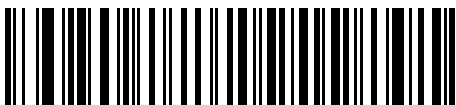

French Canadian Windows XP/2000

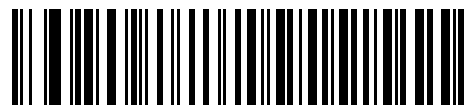

Spanish Windows

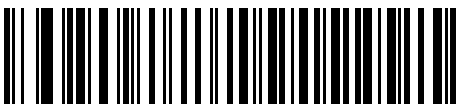

Italian Windows

Keyboard Wedge Country Types (continued)

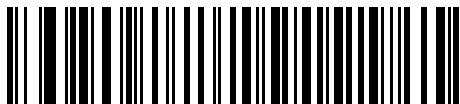

Swedish Windows



UK English Windows

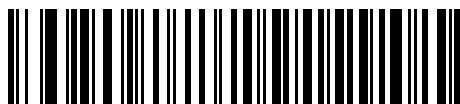

Japanese Windows



Portuguese-Brazilian Windows

Ignore Unknown Characters

Unknown characters are characters the host does not recognize. When **Send Bar Codes With Unknown Characters** is selected, all bar code data is sent except for unknown characters, and no error beeps sound on the scanner. When **Do Not Send Bar Codes With Unknown Characters** is selected, bar code data is sent up to the first unknown character, then the scanner issues an error beep.



*Send Bar Codes with Unknown Characters

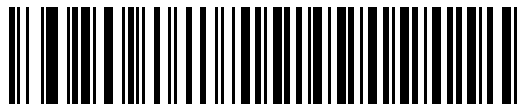

Do Not Send Bar Codes with Unknown Characters

Keystroke Delay

This is the delay in milliseconds between emulated keystrokes. Scan a bar code below to increase the delay when hosts require a slower transmission of data.



***No Delay**



Medium Delay (20 msec)

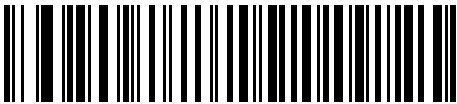

Long Delay (40 msec)

Intra-Keystroke Delay

When enabled, an additional delay is inserted between each emulated key depression and release. This sets the Keystroke Delay parameter to a minimum of 5 msec as well.

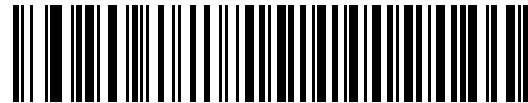

Enable Intra-Keystroke Delay



***Disable Intra-Keystroke Delay**

Alternate Numeric Keypad Emulation

This allows emulation of most other country keyboard types not listed in *Keyboard Wedge Country Types (Country Codes)* on page 5-5 in a Microsoft® operating system environment.



Enable Alternate Numeric Keypad



*Disable Alternate Numeric Keypad

Caps Lock On

When enabled, the scanner emulates keystrokes as if the Caps Lock key is always pressed. Note that if both **Caps Lock On** and **Caps Lock Override** are enabled, **Caps Lock Override** takes precedence



Enable Caps Lock On



*Disable Caps Lock On

Caps Lock Override

When enabled, on AT or AT Notebook hosts, the keyboard ignores the state of the Caps Lock key. Therefore, an 'A' in the bar code is sent as an 'A' no matter what the state of the keyboard's Caps Lock key.

✓ **NOTE** If both **Caps Lock On** and **Caps Lock Override** are enabled, **Caps Lock Override** takes precedence.

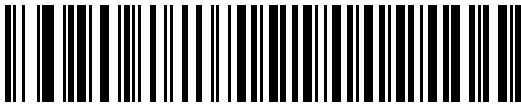

Enable Caps Lock Override

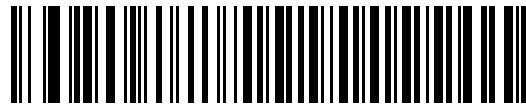

*Disable Caps Lock Override

Convert Wedge Data

When enabled, the scanner will convert all bar code data to the selected case.

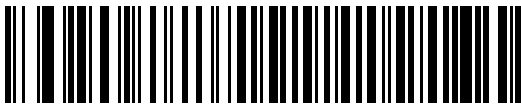

Convert to Upper Case



Convert to Lower Case

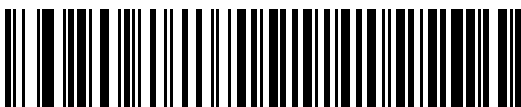

*No Convert

Function Key Mapping

ASCII values under 32 are normally sent as control key sequences (see [Table 5-2 on page 5-12](#)). When this parameter is enabled, the keys in bold are sent in place of the standard key mapping. Table entries that do not have a bold entry remain the same whether or not this parameter is enabled.



Enable Function Key Mapping

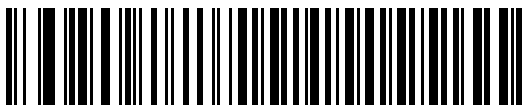

*Disable Function Key Mapping

FN1 Substitution

When enabled, the scanner replaces FN1 characters in an EAN128 bar code with a keystroke chosen by the user (see [FN1 Substitution Values on page 4-10](#)).



Enable FN1 Substitution



*Disable FN1 Substitution

Send Make and Break

When enabled, the scan codes for releasing a key are not sent.

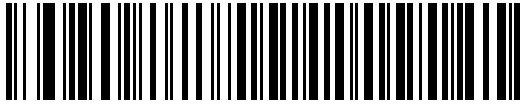

***Send Make and Break Scan Codes**

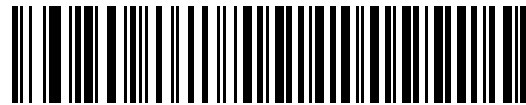

Send Make Scan Code Only

Keyboard Maps

The following keyboard maps are provided for prefix/suffix keystroke parameters. To program the prefix/suffix values, see the bar codes on [page 4-8](#).

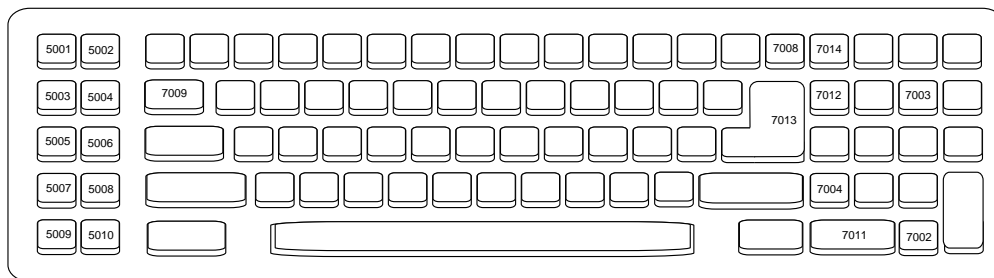

Figure 5-2 IBM PC/AT

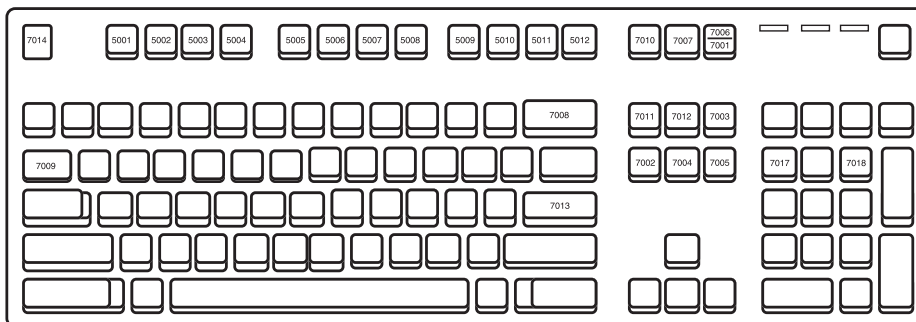

Figure 5-3 IBM PS/2

ASCII Character Set for Keyboard Wedge

- ✓ **NOTE** Code 39 Full ASCII interprets the bar code special character (\$ + % /) preceding a Code 39 character and assigns an ASCII character value to the pair. For example, when Code 39 Full ASCII is enabled and a **+B** is scanned, it is interpreted as **b**, **%J** as **?**, and **%V** as **@**. Scanning **ABC%I** outputs the keystroke equivalent of **ABC >**.

Table 5-2 Keyboard Wedge ASCII Character Set

ASCII Value	Full ASCII Code 39 Encode Character	Keystroke
1001	\$A	CTRL A
1002	\$B	CTRL B
1003	\$C	CTRL C
1004	\$D	CTRL D
1005	\$E	CTRL E
1006	\$F	CTRL F
1007	\$G	CTRL G
1008	\$H	CTRL H/ BACKSPACE ¹
1009	\$I	CTRL I/ HORIZONTAL TAB ¹
1010	\$J	CTRL J
1011	\$K	CTRL K
1012	\$L	CTRL L
1013	\$M	CTRL M/ ENTER ¹
1014	\$N	CTRL N
1015	\$O	CTRL O
1016	\$P	CTRL P
1017	\$Q	CTRL Q
1018	\$R	CTRL R
1019	\$S	CTRL S
1020	\$T	CTRL T
1021	\$U	CTRL U
1022	\$V	CTRL V

¹The keystroke in bold is sent only if the "Function Key Mapping" is enabled. Otherwise, the unbolded keystroke is sent.

Table 5-2 Keyboard Wedge ASCII Character Set (Continued)

ASCII Value	Full ASCII Code 39 Encode Character	Keystroke
1023	\$W	CTRL W
1024	\$X	CTRL X
1025	\$Y	CTRL Y
1026	\$Z	CTRL Z
1027	%A	CTRL [/ ESC ¹
1028	%B	CTRL \
1029	%C	CTRL]
1030	%D	CTRL 6
1031	%E	CTRL -
1032	Space	Space
1033	/A	!
1034	/B	"
1035	/C	#
1036	/D	\$
1037	/E	%
1038	/F	&
1039	/G	'
1040	/H	(
1041	/I)
1042	/J	*
1043	/K	+
1044	/L	,
1045	-	-
1046	.	.
1047	/O	/
1048	0	0
1049	1	1
1050	2	2

¹The keystroke in bold is sent only if the "Function Key Mapping" is enabled. Otherwise, the unbolded keystroke is sent.

Table 5-2 Keyboard Wedge ASCII Character Set (Continued)

ASCII Value	Full ASCII Code 39 Encode Character	Keystroke
1051	3	3
1052	4	4
1053	5	5
1054	6	6
1055	7	7
1056	8	8
1057	9	9
1058	/Z	:
1059	%F	;
1060	%G	<
1061	%H	=
1062	%I	>
1063	%J	?
1064	%V	@
1065	A	A
1066	B	B
1067	C	C
1068	D	D
1069	E	E
1070	F	F
1071	G	G
1072	H	H
1073	I	I
1074	J	J
1075	K	K
1076	L	L
1077	M	M
1078	N	N

¹The keystroke in bold is sent only if the "Function Key Mapping" is enabled. Otherwise, the unbolded keystroke is sent.

Table 5-2 Keyboard Wedge ASCII Character Set (Continued)

ASCII Value	Full ASCII Code 39 Encode Character	Keystroke
1079	O	O
1080	P	P
1081	Q	Q
1082	R	R
1083	S	S
1084	T	T
1085	U	U
1086	V	V
1087	W	W
1088	X	X
1089	Y	Y
1090	Z	Z
1091	%K	[
1092	%L	\
1093	%M]
1094	%N	^
1095	%O	_
1096	%W	'
1097	+A	a
1098	+B	b
1099	+C	c
1100	+D	d
1101	+E	e
1102	+F	f
1103	+G	g
1104	+H	h
1105	+I	i
1106	+J	j

¹The keystroke in bold is sent only if the "Function Key Mapping" is enabled. Otherwise, the unbolded keystroke is sent.

Table 5-2 Keyboard Wedge ASCII Character Set (Continued)

ASCII Value	Full ASCII Code 39 Encode Character	Keystroke
1107	+K	k
1108	+L	l
1109	+M	m
1110	+N	n
1111	+O	o
1112	+P	p
1113	+Q	q
1114	+R	r
1115	+S	s
1116	+T	t
1117	+U	u
1118	+V	v
1119	+W	w
1120	+X	x
1121	+Y	y
1122	+Z	z
1123	%P	{
1124	%Q	
1125	%R	}
1126	%S	~

¹The keystroke in bold is sent only if the "Function Key Mapping" is enabled. Otherwise, the unbolded keystroke is sent.

Table 5-3 Keyboard Wedge ALT Key Character Set

ALT Keys	Keystroke
2065	ALT A
2066	ALT B
2067	ALT C
2068	ALT D
2069	ALT E
2070	ALT F

Table 5-3 Keyboard Wedge ALT Key Character Set (Continued)

ALT Keys	Keystroke
2071	ALT G
2072	ALT H
2073	ALT I
2074	ALT J
2075	ALT K
2076	ALT L
2077	ALT M
2078	ALT N
2079	ALT O
2080	ALT P
2081	ALT Q
2082	ALT R
2083	ALT S
2084	ALT T
2085	ALT U
2086	ALT V
2087	ALT W
2088	ALT X
2089	ALT Y
2090	ALT Z

Table 5-4 Keyboard Wedge GIU Key Character Set

GUI Keys	Keystrokes
3000	Right Control Key
3048	GUI 0
3049	GUI 1
3050	GUI 2
3051	GUI 3
3052	GUI 4
3053	GUI 5
3054	GUI 6

Table 5-4 Keyboard Wedge GIU Key Character Set (Continued)

GUI Keys	Keystrokes
3055	GUI 7
3056	GUI 8
3057	GUI 9
3065	GUI A
3066	GUI B
3067	GUI C
3068	GUI D
3069	GUI E
3070	GUI F
3071	GUI G
3072	GUI H
3073	GUI I
3074	GUI J
3075	GUI K
3076	GUI L
3077	GUI M
3078	GUI N
3079	GUI O
3080	GUI P
3081	GUI Q
3082	GUI R
3083	GUI S
3084	GUI T
3085	GUI U
3086	GUI V
3087	GUI W
3088	GUI X
3089	GUI Y
3090	GUI Z

Table 5-5 *Keyboard Wedge F Key Character Set*

F Keys	Keystroke
5001	F1
5002	F2
5003	F3
5004	F4
5005	F5
5006	F6
5007	F7
5008	F8
5009	F9
5010	F10
5011	F11
5012	F12
5013	F13
5014	F14
5015	F15
5016	F16
5017	F17
5018	F18
5019	F19
5020	F20
5021	F21
5022	F22
5023	F23
5024	F24

Table 5-6 *Keyboard Wedge Numeric Keypad Character Set*

Numeric Keypad	Keystroke
6042	*
6043	+
6044	undefined
6045	-
6046	.
6047	/
6048	0
6049	1
6050	2
6051	3
6052	4
6053	5
6054	6
6055	7
6056	8
6057	9
6058	Enter
6059	Num Lock

Table 5-7 *Keyboard Wedge Extended Keypad Character Set*

Extended Keypad	Keystroke
7001	Break
7002	Delete
7003	Pg Up
7004	End
7005	Pg Dn
7006	Pause
7007	Scroll Lock
7008	Backspace
7009	Tab
7010	Print Screen
7011	Insert
7012	Home
7013	Enter
7014	Escape
7015	Up Arrow
7016	Dn Arrow
7017	Left Arrow
7018	Right Arrow

Chapter 6 RS-232 Interface

Introduction

This chapter describes how to set up the scanner with an RS-232 host. The RS-232 interface is used to connect the scanner to point-of-sale devices, host computers, or other devices with an available RS-232 port (e.g., com port).

If the host is not listed in [Table 6-2](#), refer to the documentation for the host device to set communication parameters to match the host.

- ✓ **NOTE** The scanner uses TTL RS-232 signal levels, which interface with most system architectures. Different cables are offered, providing TTL-to-RS-232C conversion, for system architectures requiring RS-232C signal levels. Contact Zebra Support for more information.

Throughout the programming bar code menus, default values are indicated with asterisks (*).



* Indicates Default — ***Baud Rate 57,600** — Feature/Option

Connecting an RS-232 Interface

This connection is made directly from the scanner to the host computer.

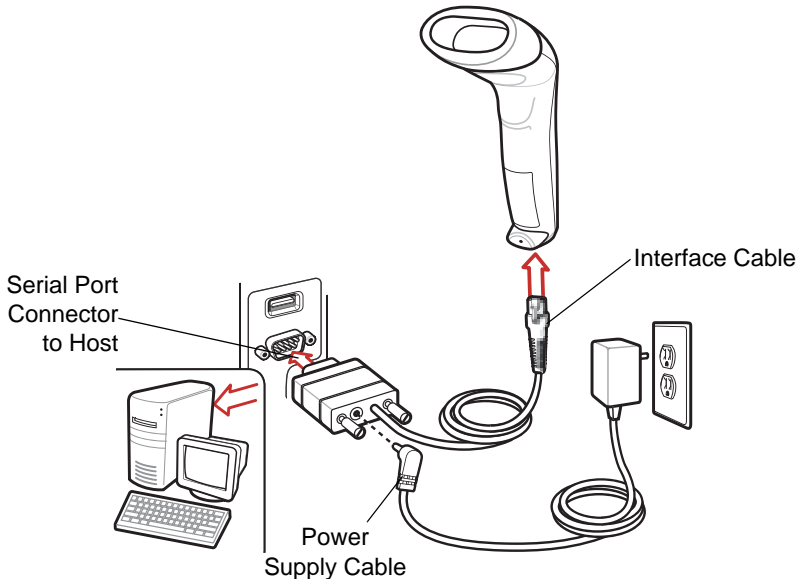

Figure 6-1 RS-232 Direct Connection

✓ **NOTE** Interface cables vary depending on configuration. The connectors illustrated in [Figure 6-1](#) are examples only. The connectors may be different than those illustrated, but the steps to connect the scanner remain the same.

1. Attach the modular connector of the RS-232 interface cable to the cable interface port on the scanner (see [Installing the Interface Cable on page 1-2](#)).
2. Connect the other end of the RS-232 interface cable to the serial port on the host.
3. Connect the power supply to the serial connector end of the RS-232 interface cable. Plug the power supply into an appropriate outlet.
4. Select the RS-232 host type by scanning the appropriate bar code from [RS-232 Host Types on page 6-6](#).
5. To modify any other parameter options, scan the appropriate bar codes in this chapter.

RS-232 Parameter Defaults

[Table 6-1](#) lists the defaults for RS-232 host parameters. If any option needs to be changed, scan the appropriate bar code(s) provided in the Parameter Descriptions section beginning on [page 6-4](#).

✓ **NOTE** See [Appendix A, Standard Defaults](#) for all user preferences, hosts, symbologies, and miscellaneous default parameters.

Table 6-1 RS-232 Defaults

Parameter	Default	Page Number
RS-232 Host Parameters		
RS-232 Host Types	Standard	6-6
Baud Rate	9600	6-7
Parity Type	None	6-8
Stop Bit Select	1 Stop Bit	6-9
Data Bits (ASCII Format)	8-Bit	6-9
Check Receive Errors	Enable	6-10
Hardware Handshaking	None	6-10
Software Handshaking	None	6-12
Host Serial Response Time-out	2 Sec	6-13
RTS Line State	Low RTS	6-14
Beep on <BEL>	Disable	6-14
Intercharacter Delay	0 msec	6-15
Nixdorf Beep/LED Options	Normal Operation	6-16
Ignore Unknown Characters	Send Bar Code	6-16

RS-232 Host Parameters

Various RS-232 hosts are set up with their own parameter default settings ([Table 6-2](#)). Selecting the ICL, Fujitsu, Wincor-Nixdorf Mode A, Wincor-Nixdorf Mode B, Olivetti, Omron, or terminal sets the defaults listed in [Table 6-2](#).

Selecting the ICL, Fujitsu, Wincor-Nixdorf Mode A, Wincor-Nixdorf Mode B, OPOS terminal enables the transmission of code ID characters listed in [Table 6-3 on page 6-5](#). These code ID characters are not programmable and are separate from the Transmit Code ID feature. The Transmit Code ID feature should not be enabled for these terminals.

Table 6-2 Terminal Specific RS-232

Parameter	Standard (Default)	ICL	Fujitsu	Wincor-Nixdorf Mode A	Wincor-Nixdorf Mode B/OPOS	Olivetti	Omron
Transmit Code ID	No	Yes	Yes	Yes	Yes	Yes	Yes
Data Transmission Format	Data as is	Data/Suffix	Data/Suffix	Data/Suffix	Data/Suffix	Prefix/Data/Suffix	Data/Suffix
Suffix	CR/LF (7013)	CR (1013)	CR (1013)	CR (1013)	CR (1013)	ETX (1002)	CR (1013)
Baud Rate	9600	9600	9600	9600	9600	9600	9600
Parity	None	Even	None	Odd	Odd	Even	None
Hardware Handshaking	None	RTS/CTS Option 3	None	RTS/CTS Option 3	RTS/CTS Option 3	None	None
Software Handshaking	None	None	None	None	None	Ack/Nak	None
Serial Response Time-out	2 Sec.	9.9 Sec.	2 Sec.	9.9 Sec.	9.9 Sec.	9.9 Sec.	9.9 Sec.
Stop Bit Select	One	One	One	One	One	One	One
ASCII Format	8-Bit	8-Bit	8-Bit	8-Bit	8-Bit	7-Bit	8-Bit
Beep On <BEL>	Disable	Disable	Disable	Disable	Disable	Disable	Disable
RTS Line State	Low	High	Low	Low	Low = No data to send	Low	High
Prefix	None	None	None	None	None	STX (1003)	None

***In the Nixdorf Mode B, if CTS is Low, scanning is disabled. When CTS is High, the user can scan bar codes.**

****If Nixdorf Mode B is scanned without the scanner connected to the proper host, it may appear unable to scan. If this happens, scan a different RS-232 host type within 5 seconds of cycling power to the scanner.**

RS-232 Host Types

To select an RS-232 host interface, scan one of the following bar codes.



***Standard RS-232**

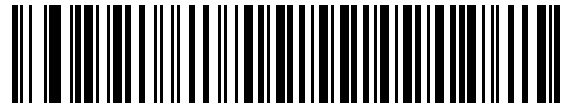

ICL RS-232



Wincor-Nixdorf RS-232 Mode A

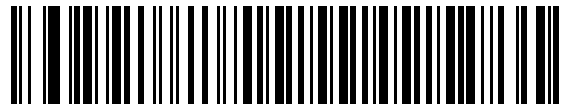

Wincor-Nixdorf RS-232 Mode B

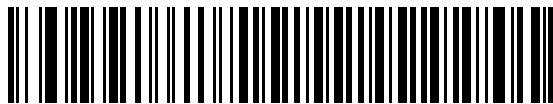

Olivetti ORS4500

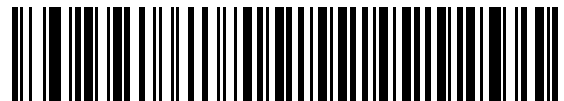

Omron

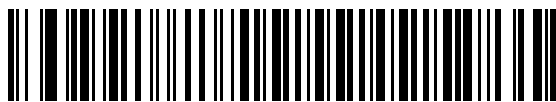

OPOS/JPOS



Fujitsu RS-232

Baud Rate

Baud rate is the number of bits of data transmitted per second. Set the scanner's baud rate to match the baud rate setting of the host device. Otherwise, data may not reach the host device or may reach it in distorted form.

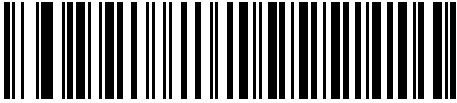

Baud Rate 600



Baud Rate 1200

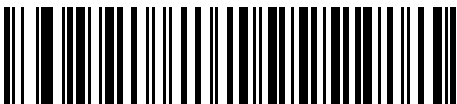

Baud Rate 2400



Baud Rate 4800

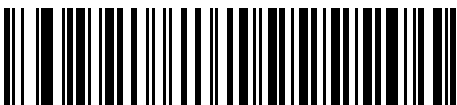

***Baud Rate 9600**

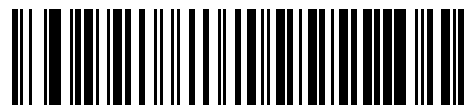

Baud Rate 19,200

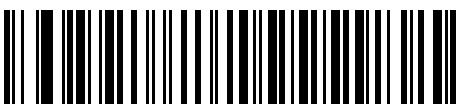

Baud Rate 38,400

Parity

A parity check bit is the most significant bit of each ASCII coded character. Select the parity type according to host device requirements.

- Select **Odd** parity and the parity bit value is set to 0 or 1, based on data, to ensure that an odd number of 1 bits are contained in the coded character.
- Select **Even** parity and the parity bit value is set to 0 or 1, based on data, to ensure that an even number of 1 bits are contained in the coded character.
- Select **Mark** parity and the parity bit is always 1.
- Select **Space** parity and the parity bit is always 0.
- Select **None** when no parity bit is required.

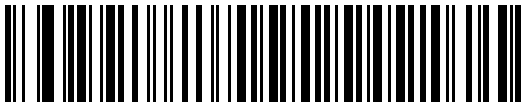

Odd



Even

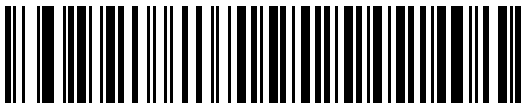

Mark



Space

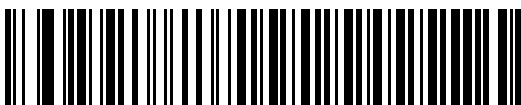

***None**

Stop Bit Select

The stop bit(s) at the end of each transmitted character marks the end of transmission of one character and prepares the receiving device for the next character in the serial data stream. The number of stop bits selected (one or two) depends on the number the receiving terminal is programmed to accommodate. Set the number of stop bits to match host device requirements.

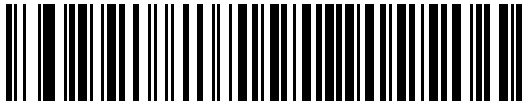

***1 Stop Bit**



2 Stop Bits

Data Bits (ASCII Format)

This parameter allows the scanner to interface with devices requiring a 7-bit or 8-bit ASCII protocol.

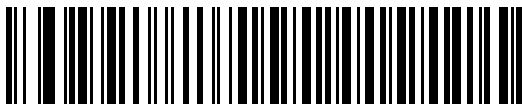

7-Bit

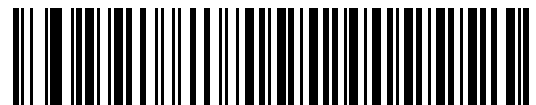

***8-Bit**

Check Receive Errors

Select whether or not the parity, framing, and overrun of received characters are checked. The parity value of received characters is verified against the parity parameter selected above.

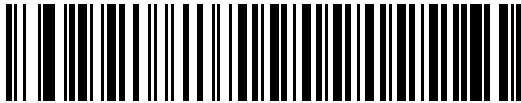

***Check For Received Errors
(Enable)**



**Do Not Check For Received Errors
(Disable)**

Hardware Handshaking

The data interface consists of an RS-232 port designed to operate either with or without the hardware handshaking lines, *Request to Send* (RTS), and *Clear to Send* (CTS).

If Standard RTS/CTS handshaking is not selected, scan data is transmitted as it becomes available. If Standard RTS/CTS handshaking is selected, scan data is transmitted according to the following sequence:

- The scanner reads the CTS line for activity. If CTS is asserted, the scanner waits up to Host Serial Response Time-out for the host to de-assert the CTS line. If, after Host Serial Response Time-out, the CTS line is still asserted, the scanner sounds a transmit error, and any scanned data is lost.
- When the CTS line is de-asserted, the scanner asserts the RTS line and waits up to Host Serial Response Time-out for the host to assert CTS. When the host asserts CTS, data is transmitted. If, after Host Serial Response Time-out, the CTS line is not asserted, the scanner sounds a transmit error, and discards the data.
- When data transmission is complete, the scanner de-asserts RTS 10 msec after sending the last character.
- The host should respond by negating CTS. The scanner checks for a de-asserted CTS upon the next transmission of data.

During the transmission of data, the CTS line should be asserted. If CTS is de-asserted for more than 50 ms between characters, the transmission is aborted, the scanner sounds a transmission error, and the data is discarded.

If the above communication sequence fails, the scanner issues an error indication. In this case, the data is lost and must be rescanned.

If Hardware Handshaking and Software Handshaking are both enabled, Hardware Handshaking takes precedence.

✓ **NOTE** The DTR signal is jumpered to the active state.

Hardware Handshaking (continued)

- **None:** Scan the bar code below if no Hardware Handshaking is desired.
- **Standard RTS/CTS:** Scan the bar code below to select Standard RTS/CTS Hardware Handshaking.
- **RTS/CTS Option 1:** When RTS/CTS Option 1 is selected, the scanner asserts RTS before transmitting and ignores the state of CTS. The scanner de-asserts RTS when the transmission is complete.
- **RTS/CTS Option 2:** When Option 2 is selected, RTS is always high or low (user-programmed logic level). However, the scanner waits for CTS to be asserted before transmitting data. If CTS is not asserted within Host Serial Response Time-out, the scanner issues an error indication and discards the data.
- **RTS/CTS Option 3:** When Option 3 is selected, the scanner asserts RTS prior to any data transmission, regardless of the state of CTS. The scanner waits up to Host Serial Response Time-out for CTS to be asserted. If CTS is not asserted during this time, the scanner issues an error indication and discards the data. The scanner de-asserts RTS when transmission is complete.

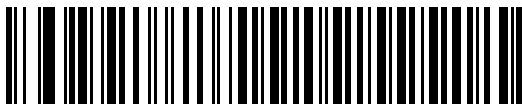

***None**

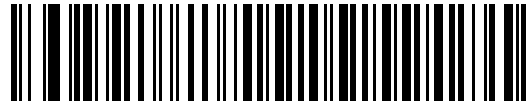

Standard RTS/CTS



RTS/CTS Option 1



RTS/CTS Option 2



RTS/CTS Option 3

Software Handshaking

This parameter offers control of the data transmission process in addition to, or instead of, that offered by hardware handshaking. There are five options.

If Software Handshaking and Hardware Handshaking are both enabled, Hardware Handshaking takes precedence.

- **None:** When this option is selected, data is transmitted immediately. No response is expected from host.
- **ACK/NAK:** When this option is selected, after transmitting data, the scanner expects either an ACK or NAK response from the host. When a NAK is received, the scanner transmits the same data again and waits for either an ACK or NAK. After three unsuccessful attempts to send data when NAKs are received, the scanner issues an error indication and discards the data.

The scanner waits up to the programmable Host Serial Response Time-out to receive an ACK or NAK. If the scanner does not get a response in this time, it issues an error indication and discards the data. There are no retries when a time-out occurs.

- **ENQ:** When this option is selected, the scanner waits for an ENQ character from the host before transmitting data. If an ENQ is not received within the Host Serial Response Time-out, the scanner issues an error indication and discards the data. The host must transmit an ENQ character at least every Host Serial Response Time-out to prevent transmission errors.
- **ACK/NAK with ENQ:** This combines the two previous options. For re-transmissions of data, due to a NAK from the host, an additional ENQ is not required.
- **XON/XOFF:** An XOFF character turns the scanner transmission off until the scanner receives an XON character. There are two situations for XON/XOFF:
 - XOFF is received before the scanner has data to send. When the scanner has data to send, it waits up to Host Serial Response Time-out for an XON character before transmission. If the XON is not received within this time, the scanner issues an error indication and discards the data.
 - XOFF is received during a transmission. Data transmission then stops after sending the current byte. When the scanner receives an XON character, it sends the rest of the data message. The scanner waits up to 30 seconds for the XON.

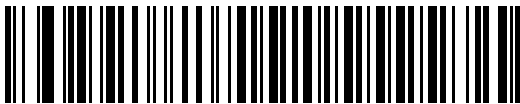

*None

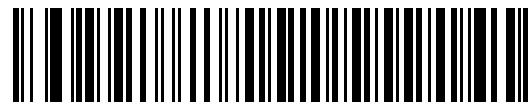

ACK/NAK



ENQ

Software Handshaking (continued)

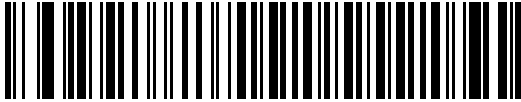

ACK/NAK with ENQ



XON/XOFF

Host Serial Response Time-out

This parameter specifies how long the scanner waits for an ACK, NAK, ENQ, XON, or CTS before determining that a transmission error occurred.

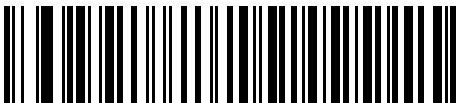

*Minimum: 2 Sec



Low: 2.5 Sec

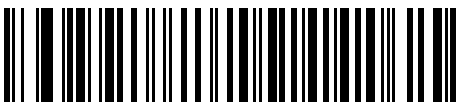

Medium: 5 Sec



High: 7.5 Sec

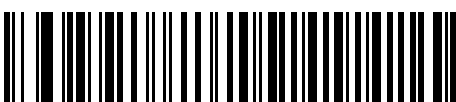

Maximum: 9.9 Sec

RTS Line State

This parameter sets the idle state of the Serial Host RTS line. Scan a bar code below to select **Low RTS** or **High RTS** line state.

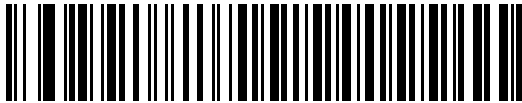

***Host: Low RTS**

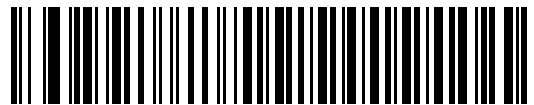

Host: High RTS

Beep on <BEL>

When this parameter is enabled, the scanner issues a beep when a <BEL> character is detected on the RS-232 serial line. <BEL> is issued to gain a user's attention to an illegal entry or other important event.

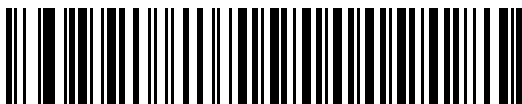

**Beep On <BEL> Character
(Enable)**

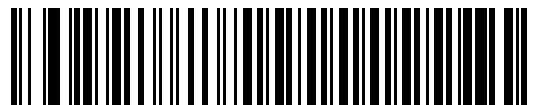

***Do Not Beep On <BEL> Character
(Disable)**

Intercharacter Delay

This parameter specifies the intercharacter delay inserted between character transmissions.



***Minimum: 0 msec**



Low: 25 msec

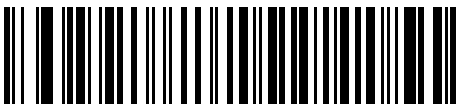

Medium: 50 msec



High: 75 msec

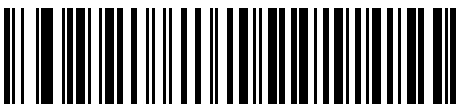

Maximum: 99 msec

Nixdorf Beep/LED Options

When Nixdorf Mode B is selected, this indicates when the scanner should beep and turn on its LED after a decode.

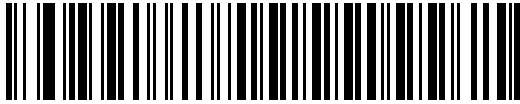

***Normal Operation**
(Beep/LED immediately after decode)



Beep/LED After Transmission



Beep/LED After CTS Pulse

Ignore Unknown Characters

Unknown characters are characters the host does not recognize. When **Send Bar Codes with Unknown Characters** is selected, all bar code data is sent except for unknown characters, and no error beeps sound on the scanner. When **Do Not Send Bar Codes With Unknown Characters** is selected, bar code data is sent up to the first unknown character and then an error beep sounds on the scanner.

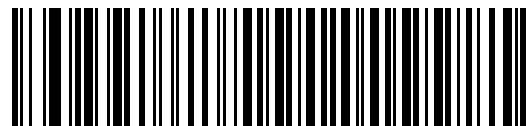

***Send Bar Code with Unknown Characters**

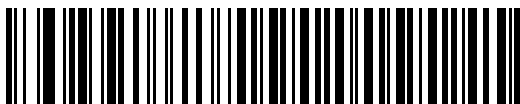

Do Not Send Bar Codes with Unknown Characters

ASCII Character Set for RS-232

The values in [Table 6-4](#) can be assigned as prefixes or suffixes for ASCII character data transmission.

Table 6-4 ASCII Character Set for RS-232

ASCII Value	Full ASCII Code 39 Encode Character	ASCII Character
1000	%U	NUL
1001	\$A	SOH
1002	\$B	STX
1003	\$C	ETX
1004	\$D	EOT
1005	\$E	ENQ
1006	\$F	ACK
1007	\$G	BELL
1008	\$H	BCKSPC
1009	\$I	HORIZ TAB
1010	\$J	LF/NW LN
1011	\$K	VT
1012	\$L	FF
1013	\$M	CR/ENTER
1014	\$N	SO
1015	\$O	SI
1016	\$P	DLE
1017	\$Q	DC1/XON
1018	\$R	DC2
1019	\$S	DC3/XOFF
1020	\$T	DC4
1021	\$U	NAK
1022	\$V	SYN
1023	\$W	ETB
1024	\$X	CAN
1025	\$Y	EM
1026	\$Z	SUB

Table 6-4 ASCII Character Set for RS-232 (Continued)

ASCII Value	Full ASCII Code 39 Encode Character	ASCII Character
1027	%A	ESC
1028	%B	FS
1029	%C	GS
1030	%D	RS
1031	%E	US
1032	Space	Space
1033	/A	!
1034	/B	"
1035	/C	#
1036	/D	\$
1037	/E	%
1038	/F	&
1039	/G	'
1040	/H	(
1041	/I)
1042	/J	*
1043	/K	+
1044	/L	,
1045	-	-
1046	.	.
1047	/O	/
1048	0	0
1049	1	1
1050	2	2
1051	3	3
1052	4	4
1053	5	5
1054	6	6
1057	7	7
1056	8	8

Table 6-4 ASCII Character Set for RS-232 (Continued)

ASCII Value	Full ASCII Code 39 Encode Character	ASCII Character
1057	9	9
1058	/Z	:
1059	%F	;
1060	%G	<
1061	%H	=
1062	%I	>
1063	%J	?
1064	%V	@
1065	A	A
1066	B	B
1067	C	C
1068	D	D
1069	E	E
1070	F	F
1071	G	G
1072	H	H
1073	I	I
1074	J	J
1075	K	K
1076	L	L
1077	M	M
1078	N	N
1079	O	O
1080	P	P
1081	Q	Q
1082	R	R
1083	S	S
1084	T	T
1085	U	U
1086	V	V

Table 6-4 ASCII Character Set for RS-232 (Continued)

ASCII Value	Full ASCII Code 39 Encode Character	ASCII Character
1087	W	W
1088	X	X
1089	Y	Y
1090	Z	Z
1091	%K	[
1092	%L	\
1093	%M]
1094	%N	^
1095	%O	_
1096	%W	`
1097	+A	a
1098	+B	b
1099	+C	c
1100	+D	d
1101	+E	e
1102	+F	f
1103	+G	g
1104	+H	h
1105	+I	i
1106	+J	j
1107	+K	k
1108	+L	l
1109	+M	m
1110	+N	n
1111	+O	o
1112	+P	p
1113	+Q	q
1114	+R	r
1115	+S	s
1116	+T	t

Table 6-4 ASCII Character Set for RS-232 (Continued)

ASCII Value	Full ASCII Code 39 Encode Character	ASCII Character
1117	+U	u
1118	+V	v
1119	+W	w
1120	+X	x
1121	+Y	y
1122	+Z	z
1123	%P	{
1124	%Q	
1125	%R	}
1126	%S	~
1127		Undefined
7013		ENTER

Chapter 7 USB Interface

Introduction

This chapter covers the connection and setup of the scanner to a USB host. The scanner attaches directly to a USB host, or a powered USB hub, and is powered by it. No additional power supply is required.

Throughout the programming bar code menus, default values are indicated with asterisks (*).

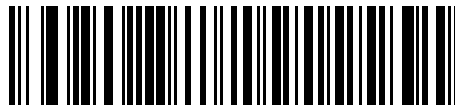

* Indicates Default — ***North American Standard USB Keyboard** — Feature/Option

Connecting a USB Interface

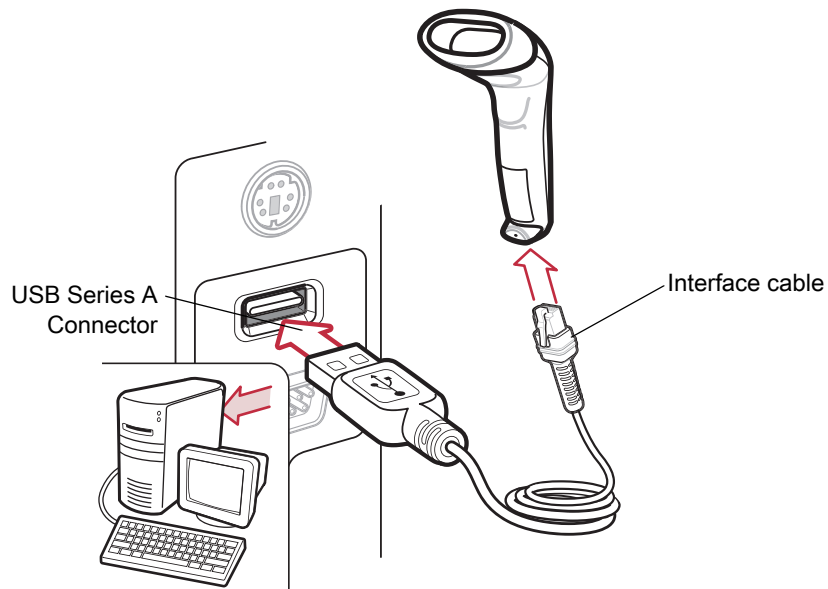

Figure 1 USB Connection

The scanner connects with USB capable hosts including:

- Desktop PCs and Notebooks
- Apple™ iMac, G4, iBooks (North America only)
- IBM SurePOS terminals
- Sun, IBM, and other network computers that support more than one keyboard.

The following operating systems support the scanner through USB:

- Windows 98, 2000, ME, XP
- MacOS 8.5 and above
- IBM 4690 OS.

The scanner will also interface with other USB hosts which support USB Human Interface Devices (HID).



NOTE: Interface cables vary depending on configuration. The connectors illustrated in [Figure 1](#) are examples only. The connectors may be different than those illustrated, but the steps to connect the scanner remain the same.

To set up the scanner:

1. Attach the modular connector of the USB interface cable to the cable interface port on the scanner (see [Installing the Interface Cable on page 1-2](#)).
2. Plug the series A connector in the USB host or hub, or plug the Plus Power connector in an available port of the IBM SurePOS terminal.
3. Select the USB device type by scanning the appropriate bar code from [USB Device Type on page 7-4](#).
4. On first installation when using Windows, the software prompts to select or install the Human Interface Device driver. To install this driver, provided by Windows, click *Next* through all the choices and click *Finished* on the last choice. The scanner powers up during this installation.
5. To modify any other parameter options, scan the appropriate bar codes in this chapter.

If problems occur with the system, see [Troubleshooting on page 3-2](#).

USB Parameter Defaults

[Table 1](#) lists the defaults for USB host parameters. If any option needs to be changed, scan the appropriate bar code(s) provided in the Parameter Descriptions section beginning on [page 7-4](#).

✓ **NOTE:** See [Appendix A, Standard Defaults](#) for all user preferences, hosts, symbologies, and miscellaneous default parameters.

Table 1 USB Defaults

Parameter	Default	Page Number
USB Host Parameters		
USB Device Type	USB HID Keyboard	7-4
USB Country Keyboard Types (Country Codes)	North American	7-5
USB Keystroke Delay	No Delay	7-7
USB CAPS Lock Override	Disable	7-7
USB Ignore Unknown Characters	Send	7-8
Emulate Keypad	Disable	7-8
USB FN1 Substitution	Disable	7-9
Function Key Mapping	Disable	7-9
Simulated Caps Lock	Disable	7-10
Convert Case	No Case Conversion	7-10

USB Host Parameters

USB Device Type

Select the desired USB device type.



NOTES **1** When changing USB Device Types, the scanner automatically restarts. The scanner issues the standard startup beep sequences.

2. Select **IBM Hand-held USB** to transmit data only once when an IBM register issues a Scan Disable command. If the register issues a Scan Enable command before the timeout expires, scanning can continue. If a Scan Enable does not occur within the timeout, the scanner issues 4 long low transmission error beeps, and data does not transmit. You can then scan again under the same criteria.

3. Select **OPOS (IBM Hand-held with Full Disable)** to completely shut off the scanner when an IBM register issues a Scan Disable command, including aim, decoding, and data transmission.

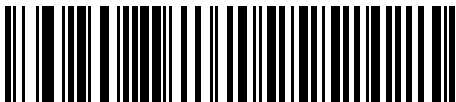

*USB HID Keyboard



IBM Table Top USB

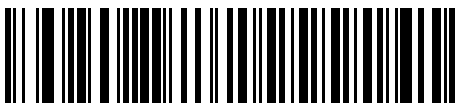

IBM Hand-Held USB



OPOS (IBM Hand-held with Full Disable)

USB Country Keyboard Types (Country Codes)

Scan the bar code corresponding to the keyboard type. This setting applies only to the USB HID Keyboard device.

✓ **NOTE:** When changing USB country keyboard types the scanner automatically resets. The scanner issues the standard startup beep sequences.

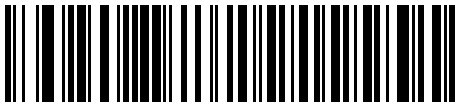

*North American Standard USB Keyboard



German Windows

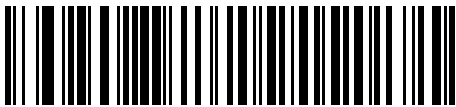

French Windows



French Canadian Windows 95/98



French Canadian Windows 2000/XP



Spanish Windows

USB Country Keyboard Types (Country Codes continued)



Italian Windows



Swedish Windows

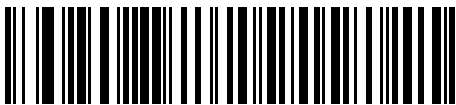

UK English Windows

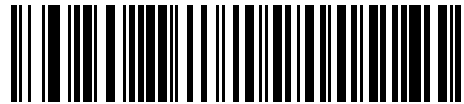

Japanese Windows (ASCII)

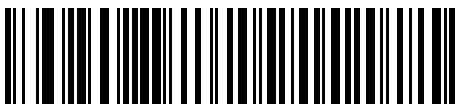

Portuguese-Brazilian Windows

USB Keystroke Delay

This parameter sets the delay, in milliseconds, between emulated keystrokes. Scan a bar code below to increase the delay when hosts require a slower transmission of data.

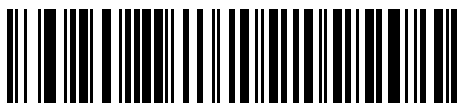

***No Delay**



Medium Delay (20 msec)

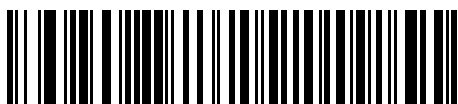

Long Delay (40 msec)

USB CAPS Lock Override

This option applies only to the USB HID Keyboard device. When enabled, the case of the data is preserved regardless of the state of the caps lock key. This setting is always enabled for the “Japanese, Windows (ASCII)” keyboard type and can not be disabled.

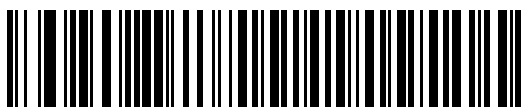

**Override Caps Lock Key
(Enable)**



***Do Not Override Caps Lock Key
(Disable)**

USB Ignore Unknown Characters

This option applies only to the USB HID Keyboard device and IBM device. Unknown characters are characters the host does not recognize. When **Send Bar Codes With Unknown Characters** is selected, all bar code data is sent except for unknown characters, and no error beeps sound. When **Do Not Send Bar Codes With Unknown Characters** is selected, bar code data is sent up to the first unknown character, then the scanner issues an error beep.

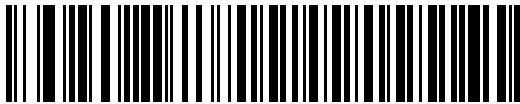

***Send Bar Codes with Unknown Characters**



Do Not Send Bar Codes with Unknown Characters

Emulate Keypad

When enabled, all characters are sent as ASCII sequences over the numeric keypad. For example ASCII A would be sent as “ALT make” 0 6 5 “ALT Break.”



***Disable Keypad Emulation**

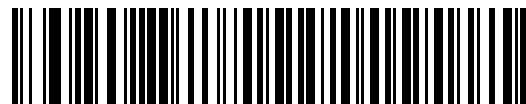

Enable Keypad Emulation

USB Keyboard FN 1 Substitution

This option applies only to the USB HID Keyboard device. When enabled, this allows replacement of any FN 1 characters in an EAN 128 bar code with a Key Category and value chosen by the user (see [FN1 Substitution Values on page 4-10](#) to set the Key Category and Key Value).

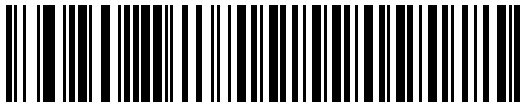

Enable FN1 Substitution



***Disable FN1 Substitution**

Function Key Mapping

ASCII values under 32 are normally sent as a control-key sequences (see [Table 2 on page 7-11](#)). When this parameter is enabled, the keys in bold are sent in place of the standard key mapping. Table entries that do not have a bold entry remain the same whether or not this parameter is enabled.

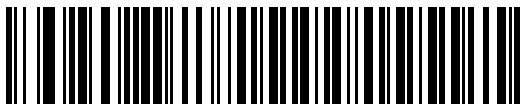

***Disable Function Key Mapping**

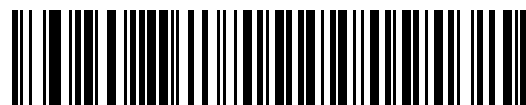

Enable Function Key Mapping

Simulated Caps Lock

When enabled, the scanner will invert upper and lower case characters on the scanner bar code as if the Caps Lock state is enabled on the keyboard. This inversion is done regardless of the current state of the keyboard's Caps Lock state.

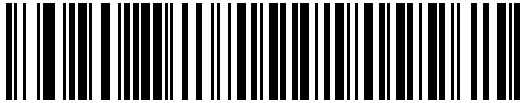

***Disable Simulated Caps Lock**

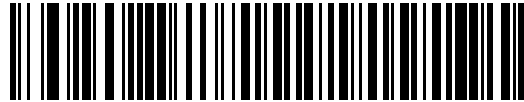

Enable Simulated Caps Lock

Convert Case

When enabled, the scanner will convert all bar code data to the selected case.

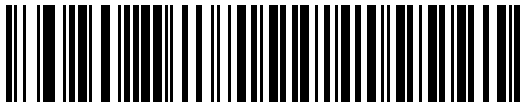

***No Case Conversion**

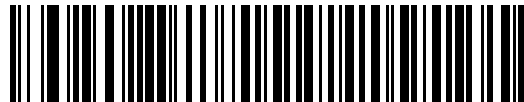

Convert All to Upper Case

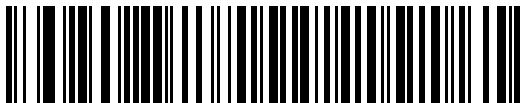

Convert All to Lower Case

ASCII Character Set for USB

Table 2 ASCII Character Set for USB

ASCII Value	Full ASCII Code 39 Encode Character	Keystroke
1000	%U	CTRL 2
1001	\$A	CTRL A
1002	\$B	CTRL B
1003	\$C	CTRL C
1004	\$D	CTRL D
1005	\$E	CTRL E
1006	\$F	CTRL F
1007	\$G	CTRL G
1008	\$H	CTRL H/ BACKSPACE ¹
1009	\$I	CTRL I/ HORIZONTAL TAB ¹
1010	\$J	CTRL J
1011	\$K	CTRL K
1012	\$L	CTRL L
1013	\$M	CTRL M/ ENTER ¹
1014	\$N	CTRL N
1015	\$O	CTRL O
1016	\$P	CTRL P
1017	\$Q	CTRL Q
1018	\$R	CTRL R
1019	\$S	CTRL S
1020	\$T	CTRL T
1021	\$U	CTRL U
1022	\$V	CTRL V
1023	\$W	CTRL W
1024	\$X	CTRL X

¹The keystroke in bold is sent only if the “Function Key Mapping” is enabled. Otherwise, the unbolded keystroke is sent.

Table 2 ASCII Character Set for USB (Continued)

ASCII Value	Full ASCII Code 39 Encode Character	Keystroke
1025	\$Y	CTRL Y
1026	\$Z	CTRL Z
1027	%A	CTRL [/ ESC ¹
1028	%B	CTRL \
1029	%C	CTRL]
1030	%D	CTRL 6
1031	%E	CTRL -
1032	Space	Space
1033	/A	!
1034	/B	“
1035	/C	#
1036	/D	\$
1037	/E	%
1038	/F	&
1039	/G	,
1040	/H	(
1041	/I)
1042	/J	*
1043	/K	+
1044	/L	,
1045	-	-
1046	.	.
1047	/O	/
1048	0	0
1049	1	1
1050	2	2
1051	3	3
1052	4	4

¹The keystroke in bold is sent only if the “Function Key Mapping” is enabled. Otherwise, the unbolded keystroke is sent.

Table 2 ASCII Character Set for USB (Continued)

ASCII Value	Full ASCII Code 39 Encode Character	Keystroke
1053	5	5
1054	6	6
1055	7	7
1056	8	8
1057	9	9
1058	/Z	:
1059	%F	;
1060	%G	<
1061	%H	=
1062	%I	>
1063	%J	?
1064	%V	@
1065	A	A
1066	B	B
1067	C	C
1068	D	D
1069	E	E
1070	F	F
1071	G	G
1072	H	H
1073	I	I
1074	J	J
1075	K	K
1076	L	L
1077	M	M
1078	N	N
1079	O	O
1080	P	P

¹The keystroke in bold is sent only if the “Function Key Mapping” is enabled. Otherwise, the unbolded keystroke is sent.

Table 2 ASCII Character Set for USB (Continued)

ASCII Value	Full ASCII Code 39 Encode Character	Keystroke
1081	Q	Q
1082	R	R
1083	S	S
1084	T	T
1085	U	U
1086	V	V
1087	W	W
1088	X	X
1089	Y	Y
1090	Z	Z
1091	%K	[
1092	%L	\
1093	%M]
1094	%N	^
1095	%O	_
1096	%W	`
1097	+A	a
1098	+B	b
1099	+C	c
1100	+D	d
1101	+E	e
1102	+F	f
1103	+G	g
1104	+H	h
1105	+I	i
1106	+J	j
1107	+K	k
1108	+L	l

¹The keystroke in bold is sent only if the “Function Key Mapping” is enabled. Otherwise, the unbolded keystroke is sent.

Table 2 ASCII Character Set for USB (Continued)

ASCII Value	Full ASCII Code 39 Encode Character	Keystroke
1109	+M	m
1110	+N	n
1111	+O	o
1112	+P	p
1113	+Q	q
1114	+R	r
1115	+S	s
1116	+T	t
1117	+U	u
1118	+V	v
1119	+W	w
1120	+X	x
1121	+Y	y
1122	+Z	z
1123	%P	{
1124	%Q	
1125	%R	}
1126	%S	~

¹The keystroke in bold is sent only if the “Function Key Mapping” is enabled. Otherwise, the unbolded keystroke is sent.

Table 3 USB ALT Key Character Set

ALT Keys	Keystroke
2064	ALT 2
2065	ALT A
2066	ALT B
2067	ALT C
2068	ALT D
2069	ALT E
2070	ALT F
2071	ALT G
2072	ALT H
2073	ALT I
2074	ALT J
2075	ALT K
2076	ALT L
2077	ALT M
2078	ALT N
2079	ALT O
2080	ALT P
2081	ALT Q
2082	ALT R
2083	ALT S
2084	ALT T
2085	ALT U
2086	ALT V
2087	ALT W
2088	ALT X
2089	ALT Y
2090	ALT Z

Table 4 USB GUI Key Character Set

GUI Key	Keystroke
3000	Right Control Key
3048	GUI 0
3049	GUI 1
3050	GUI 2
3051	GUI 3
3052	GUI 4
3053	GUI 5
3054	GUI 6
3055	GUI 7
3056	GUI 8
3057	GUI 9
3065	GUI A
3066	GUI B
3067	GUI C
3068	GUI D
3069	GUI E
3070	GUI F
3071	GUI G
3072	GUI H
3073	GUI I
3074	GUI J
3075	GUI K
3076	GUI L
3077	GUI M
3078	GUI N
3079	GUI O
3080	GUI P

Note: GUI Shift Keys - The Apple TM iMac keyboard has an apple key on either side of the space bar. Windows-based systems have a GUI key to the left of the left ALT key, and to the right of the right ALT key.

Table 4 USB GUI Key Character Set (Continued)

GUI Key	Keystroke
3081	GUI Q
3082	GUI R
3083	GUI S
3084	GUI T
3085	GUI U
3086	GUI V
3087	GUI W
3088	GUI X
3089	GUI Y
3090	GUI Z

Note: GUI Shift Keys - The Apple TM iMac keyboard has an apple key on either side of the space bar. Windows-based systems have a GUI key to the left of the left ALT key, and to the right of the right ALT key.

Table 5 USB F Key Character Set

F Keys	Keystroke
5001	F1
5002	F2
5003	F3
5004	F4
5005	F5
5006	F6
5007	F7
5008	F8
5009	F9
5010	F10
5011	F11
5012	F12
5013	F13
5014	F14
5015	F15

Table 5 USB F Key Character Set (Continued)

F Keys	Keystroke
5016	F16
5017	F17
5018	F18
5019	F19
5020	F20
5021	F21
5022	F22
5023	F23
5024	F24

Table 6 USB Numeric Keypad Character Set

Numeric Keypad	Keystroke
6042	*
6043	+
6044	undefined
6045	-
6046	.
6047	/
6048	0
6049	1
6050	2
6051	3
6052	4
6053	5
6054	6
6055	7
6056	8
6057	9
6058	Enter
6059	Num Lock

Table 7 USB Extended Keypad Character Set

Extended Keypad	Keystroke
7001	Break
7002	Delete
7003	PgUp
7004	End
7005	Pg Dn
7006	Pause
7007	Scroll Lock
7008	Backspace
7009	Tab
7010	Print Screen
7011	Insert
7012	Home
7013	Enter
7014	Escape
7015	Up Arrow
7016	Down Arrow
7017	Left Arrow
7018	Right Arrow

Chapter 8 Symbologies

Introduction

This chapter describes symbology features and provides the programming bar codes for selecting these features. Before programming, follow the instructions in [Chapter 1, Getting Started](#).

The scanner is shipped with the settings shown in the [Symbology Defaults on page 8-2](#) (also see [Appendix A, Standard Defaults](#) for all host device and miscellaneous defaults). If the default values suit requirements, programming is not necessary.

To set feature values, scan a single bar code or a short bar code sequence. The settings are stored in non-volatile memory and are preserved even when the scanner is powered down.

If not using a USB cable, select a host type (see each host chapter for specific host information) after the power-up beeps sound. This is only necessary upon the first power-up when connected to a new host.

To return all features to default values, scan the appropriate default bar code on [page 4-3](#). Throughout the programming bar code menus, default values are indicated with asterisks (*).



* Indicates Default ——— *Enable UPC-A ——— Feature/Option

Scanning Sequence Examples

In most cases, scanning one bar code sets the parameter value. For example, to transmit bar code data without the UPC-A check digit, simply scan the **Do Not Transmit UPC-A Check Digit** bar code under [Transmit UPC-A Check Digit on page 8-12](#). The scanner issues a fast warble beep and the LED turns green, signifying a successful parameter entry.

Other parameters, such as **Set Length(s) for D 2 of 5**, require scanning several bar codes. See the individual parameter, such as **Set Length(s) for D 2 of 5**, for this procedure.

Errors While Scanning

Unless otherwise specified, to correct an error during a scanning sequence, just re-scan the correct parameter.

Symbology Parameter Defaults

Table 8-1 lists the defaults for all symbologies parameters. To change any option, scan the appropriate bar code(s) provided in the Symbologies Parameters section beginning on [page 8-5](#).

✓ **NOTE** See [Appendix A, Standard Defaults](#) for all user preferences, hosts, symbologies, and miscellaneous default parameters.

Table 8-1 *Symbology Defaults*

Parameter	Default	Page Number
UPC/EAN		
UPC-A	Enable	8-5
UPC-E	Enable	8-5
UPC-E1	Disable	8-6
EAN-8/JAN 8	Enable	8-7
EAN-13/JAN 13	Enable	8-7
Bookland EAN	Disable	8-7
Decode UPC/EAN/JAN Supplementals (2 and 5 digits)	Ignore	8-8
User-Programmable Supplementals		8-11
Decode UPC/EAN/JAN Supplemental Redundancy	7	8-11
Transmit UPC-A Check Digit	Enable	8-12
Transmit UPC-E Check Digit	Enable	8-12
Transmit UPC-E1 Check Digit	Enable	8-13
UPC-A Preamble	System Character	8-13
UPC-E Preamble	System Character	8-14
UPC-E1 Preamble	System Character	8-15
Convert UPC-E to A	Disable	8-15
Convert UPC-E1 to A	Disable	8-16
EAN-8/JAN-8 Extend	Disable	8-16
Bookland ISBN Format	ISBN-10	8-17
UCC Coupon Extended Code	Disable	8-18

Table 8-1 Symbology Defaults (Continued)

Parameter	Default	Page Number
Code 128		
Code 128	Enable	8-18
GS1-128 (formerly UCC/EAN-128)	Enable	8-19
ISBT 128 (non-concatenated)	Enable	8-19
Code 39		
Code 39	Enable	8-20
Trioptic Code 39	Disable	8-20
Convert Code 39 to Code 32 (Italian Pharmacy Code)	Disable	8-21
Code 32 Prefix	Disable	8-21
Set Length(s) for Code 39	2 to 55	8-22
Code 39 Check Digit Verification	Disable	8-23
Transmit Code 39 Check Digit	Disable	8-23
Code 39 Full ASCII Conversion	Disable	8-24
Buffer Code 39	Disable	8-24
Code 93		
Code 93	Disable	8-27
Set Length(s) for Code 93	4 to 55	8-27
Code 11		
Code 11	Disable	8-28
Set Lengths for Code 11	4 to 55	8-29
Code 11 Check Digit Verification	Disable	8-30
Transmit Code 11 Check Digit(s)	Disable	8-30
Interleaved 2 of 5 (ITF)		
Interleaved 2 of 5 (ITF)	Enable	8-31
Set Lengths for I 2 of 5	14	8-31
I 2 of 5 Check Digit Verification	Disable	8-33
Transmit I 2 of 5 Check Digit	Disable	8-33
Convert I 2 of 5 to EAN 13	Disable	8-34

Table 8-1 Symbology Defaults (Continued)

Parameter	Default	Page Number
Discrete 2 of 5 (DTF)		
Discrete 2 of 5	Disable	8-34
Set Length(s) for D 2 of 5	12	8-35
Chinese 2 of 5		
Enable/Disable Chinese 2 of 5	Disable	8-36
Codabar (NW - 7)		
Codabar	Disable	8-36
Set Lengths for Codabar	5 to 55	8-37
CLSI Editing	Disable	8-38
NOTIS Editing	Disable	8-38
MSI		
MSI	Disable	8-39
Set Length(s) for MSI	2 to 55	8-39
MSI Check Digits	One	8-40
Transmit MSI Check Digit	Disable	8-41
MSI Check Digit Algorithm	Mod 10/Mod 10	8-41
GS1 DataBar (formerly RSS, Reduced Space Symbology)		
GS1 DataBar Omnidirectional (formerly GS1 DataBar-14)	Disable	8-42
GS1 DataBar Limited	Disable	8-42
GS1 DataBar Expanded	Disable	8-42
Convert GS1 DataBar to UPC/EAN	Disable	8-43
Symbology - Specific Security Levels		
Redundancy Level	1	8-44
Security Levels	0	8-46
Bi-directional Redundancy	Disable	8-47

UPC/EAN

Enable/Disable UPC-A/UPC-E

To enable or disable UPC-A or UPC-E, scan the appropriate bar code below.

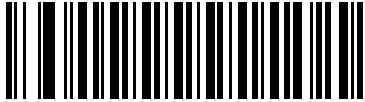

*Enable UPC-A



Disable UPC-A

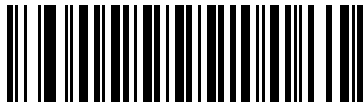

*Enable UPC-E

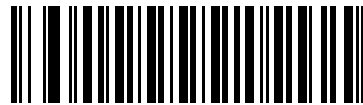

Disable UPC-E

Enable/Disable UPC-E1

UPC-E1 is disabled by default.

To enable or disable UPC-E1, scan the appropriate bar code below.

✓ **NOTE** UPC-E1 is not a UCC (Uniform Code Council) approved symbology.

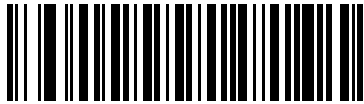

Enable UPC-E1

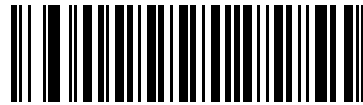

*Disable UPC-E1

Enable/Disable EAN-13/EAN-8

To enable or disable EAN-13 or EAN-8, scan the appropriate bar code below.

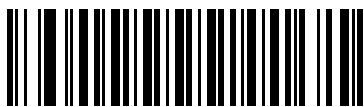

*Enable EAN-13



Disable EAN-13



*Enable EAN-8



Disable EAN-8

Enable/Disable Bookland EAN

To enable or disable Bookland EAN, scan the appropriate bar code below.



Enable Bookland EAN



*Disable Bookland EAN



NOTE If you enable Bookland EAN, select a [Bookland ISBN Format on page 8-17](#). Also select either Decode UPC/EAN Supplementals, Autodiscriminate UPC/EAN Supplementals, or Enable 978/979 Supplemental Mode in [Decode UPC/EAN/JAN Supplementals on page 8-8](#).

Decode UPC/EAN/JAN Supplementals

Supplementals are bar codes appended according to specific format conventions (e.g., UPC A+2, UPC E+2, EAN 13+2). The following options are available:

- If you select **Ignore UPC/EAN with Supplementals**, and the scanner is presented with a UPC/EAN plus supplemental symbol, the scanner decodes UPC/EAN and ignores the supplemental characters.
- If you select **Decode UPC/EAN with Supplementals**, the scanner only decodes UPC/EAN symbols with supplemental characters, and ignores symbols without supplementals.
- If you select **Autodiscriminate UPC/EAN Supplementals**, the scanner decodes UPC/EAN symbols with supplemental characters immediately. If the symbol does not have a supplemental, the scanner must decode the bar code the number of times set via [UPC/EAN/JAN Supplemental Redundancy on page 8-11](#) before transmitting its data to confirm that there is no supplemental.
- If you select one of the following **Supplemental Mode** options, the scanner immediately transmits EAN-13 bar codes starting with that prefix that have supplemental characters. If the symbol does not have a supplemental, the scanner must decode the bar code the number of times set via [UPC/EAN/JAN Supplemental Redundancy on page 8-11](#) before transmitting its data to confirm that there is no supplemental. The scanner transmits UPC/EAN bar codes that do not have that prefix immediately.
 - **Enable 378/379 Supplemental Mode**
 - **Enable 978/979 Supplemental Mode**



NOTE If you select 978/979 Supplemental Mode and are scanning Bookland EAN bar codes, see [Enable/Disable Bookland EAN on page 8-7](#) to enable Bookland EAN, and select a format using [Bookland ISBN Format on page 8-17](#).

- **Enable 977 Supplemental Mode**
- **Enable 414/419/434/439 Supplemental Mode**
- **Enable 491 Supplemental Mode**
- **Enable Smart Supplemental Mode** - applies to EAN-13 bar codes starting with any prefix listed previously.
- **Supplemental User-Programmable Type 1** - applies to EAN-13 bar codes starting with a 3-digit user-defined prefix. [User-Programmable Supplementals on page 8-11](#).
- **Supplemental User-Programmable Type 1 and 2** - applies to EAN-13 bar codes starting with either of two 3-digit user-defined prefixes. Set the 3-digit prefixes using [User-Programmable Supplementals on page 8-11](#).
- **Smart Supplemental Plus User-Programmable 1** - applies to EAN-13 bar codes starting with any prefix listed previously or the user-defined prefix set using [User-Programmable Supplementals on page 8-11](#).
- **Smart Supplemental Plus User-Programmable 1 and 2** - applies to EAN-13 bar codes starting with any prefix listed previously or one of the two user-defined prefixes set using [User-Programmable Supplementals on page 8-11](#).



NOTE To minimize the risk of invalid data transmission, select either to decode or ignore supplemental characters.

Decode UPC/EAN/JAN Supplementals (continued)



Decode UPC/EAN/JAN Only With Supplementals
(01h)



*Ignore Supplementals
(00h)

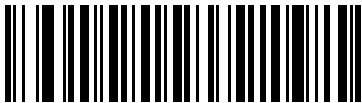

Autodiscriminate UPC/EAN/JAN Supplementals
(02h)



Enable 378/379 Supplemental Mode
(04h)



Enable 978/979 Supplemental Mode
(05h)



Enable 977 Supplemental Mode
(07h)

Decode UPC/EAN/JAN Supplementals (continued)



Enable 414/419/434/439 Supplemental Mode
(06h)



Enable 491 Supplemental Mode
(08h)



Enable Smart Supplemental Mode
(03h)



Supplemental User-Programmable Type 1
(09h)



Supplemental User-Programmable Type 1 and 2
(0Ah)



Smart Supplemental Plus User-Programmable 1
(0Bh)



Smart Supplemental Plus User-Programmable 1 and 2
(0Ch)

User-Programmable Supplementals

If you selected a Supplemental User-Programmable option from [Decode UPC/EAN/JAN Supplementals on page 8-8](#), select **User-Programmable Supplemental 1** to set the 3-digit prefix. Then select the 3 digits using the numeric bar codes beginning on [page D-1](#). Select **User-Programmable Supplemental 2** to set a second 3-digit prefix. Then select the 3 digits using the numeric bar codes beginning on [page D-1](#).



User-Programmable Supplemental 1



User-Programmable Supplemental 2

UPC/EAN/JAN Supplemental Redundancy

With **Autodiscriminate UPC/EAN/JAN Supplementals** selected, this option adjusts the number of times a symbol without supplementals is decoded before transmission. The range is from two to thirty times. Five or above is recommended when decoding a mix of UPC/EAN symbols with and without supplementals, and the autodiscriminate option is selected. The default is set at 7.

Scan the bar code below to set a decode redundancy value. Next, scan two numeric bar codes in [Appendix D, Numeric Bar Codes](#). Single digit numbers must have a leading zero. To correct an error or change a selection, scan **Cancel** on [page D-3](#).

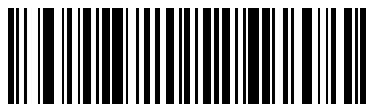

UPC/EAN/JAN Supplemental Redundancy

Transmit UPC-A Check Digit

The check digit is the last character of the symbol used to verify the integrity of the data. Scan the appropriate bar code below to transmit the bar code data with or without the UPC-A check digit. It is always verified to guarantee the integrity of the data.

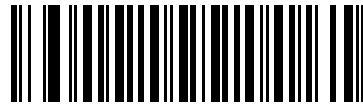

***Transmit UPC-A Check Digit**



Do Not Transmit UPC-A Check Digit

Transmit UPC-E Check Digit

The check digit is the last character of the symbol used to verify the integrity of the data. Scan the appropriate bar code below to transmit the bar code data with or without the UPC-E check digit. It is always verified to guarantee the integrity of the data.

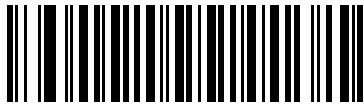

***Transmit UPC-E Check Digit**



Do Not Transmit UPC-E Check Digit

Transmit UPC-E1 Check Digit

The check digit is the last character of the symbol used to verify the integrity of the data. Scan the appropriate bar code below to transmit the bar code data with or without the UPC-E1 check digit. It is always verified to guarantee the integrity of the data.

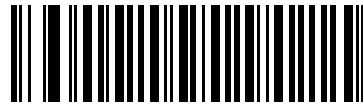

***Transmit UPC-E1 Check Digit**

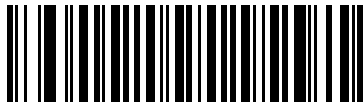

Do Not Transmit UPC-E1 Check Digit

UPC-A Preamble

Preamble characters are part of the UPC symbol consisting of Country Code and System Character. Three options are given for transmitting UPC-A preamble to the host device: transmit System Character only, transmit System Character and Country Code ("0" for USA), and no preamble transmitted. Scan a bar code below to match the host system.

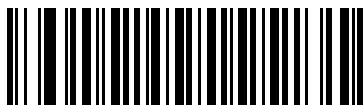

**No Preamble
<DATA>**

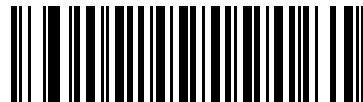

***System Character
<SYSTEM CHARACTER> <DATA>**

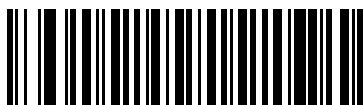

**System Character & Country Code
< COUNTRY CODE> <SYSTEM CHARACTER>
<DATA>**

UPC-E Preamble

Preamble characters are part of the UPC symbol consisting of Country Code and System Character. Three options are given for transmitting UPC-E preamble to the host device: transmit System Character only, transmit System Character and Country Code ("0" for USA), and no preamble transmitted. Scan a bar code below to match the host system.

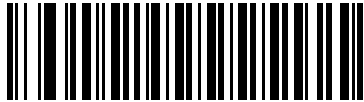

No Preamble
(<DATA>)

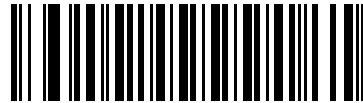

***System Character**
(<SYSTEM CHARACTER> <DATA>)

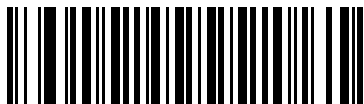

System Character & Country Code
(< COUNTRY CODE> <SYSTEM CHARACTER>
<DATA>)

UPC-E1 Preamble

Preamble characters are part of the UPC symbol consisting of Country Code and System Character. Three options are given for transmitting UPC-E1 preamble to the host device: transmit System Character only, transmit System Character and Country Code ("0" for USA), and no preamble transmitted. Scan a bar code below to match the host system.

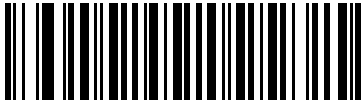

No Preamble
(<DATA>)



***System Character**
(<SYSTEM CHARACTER> <DATA>)



System Character & Country Code
(< COUNTRY CODE> <SYSTEM CHARACTER>
<DATA>)

Convert UPC-E to UPC-A

Enable this to convert UPC-E (zero suppressed) decoded data to UPC-A format before transmission. After conversion, the data follows UPC-A format and is affected by UPC-A programming selections (e.g., Preamble, Check Digit).

When disabled, UPC-E decoded data is transmitted as UPC-E data, without conversion.

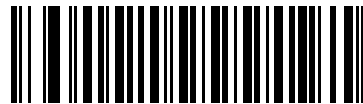

Convert UPC-E to UPC-A
(Enable)

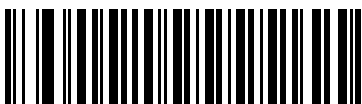

***Do Not Convert UPC-E to UPC-A**
(Disable)

Convert UPC-E1 to UPC-A

Enable this to convert UPC-E1 decoded data to UPC-A format before transmission. After conversion, the data follows UPC-A format and is affected by UPC-A programming selections (e.g., Preamble, Check Digit).

When disabled, UPC-E1 decoded data is transmitted as UPC-E1 data, without conversion.

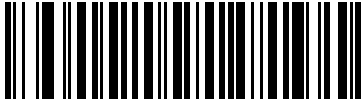

**Convert UPC-E1 to UPC-A
(Enable)**

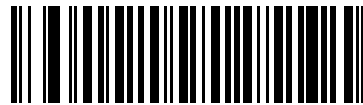

***Do Not Convert UPC-E1 to UPC-A
(Disable)**

EAN-8/JAN-8 Extend

When enabled, this parameter adds five leading zeros to decoded EAN-8 symbols to make them compatible in format to EAN-13 symbols.

When disabled, EAN-8 symbols are transmitted as is.

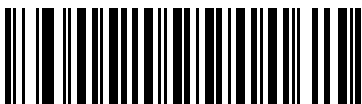

Enable EAN/JAN Zero Extend

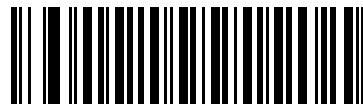

***Disable EAN/JAN Zero Extend**

Bookland ISBN Format

If you enabled Bookland EAN using [Enable/Disable Bookland EAN on page 8-7](#), select one of the following formats for Bookland data:

- **Bookland ISBN-10** - The scanner reports Bookland data starting with 978 in traditional 10-digit format with the special Bookland check digit for backward-compatibility. Data starting with 979 is not considered Bookland in this mode.
- **Bookland ISBN-13** - The scanner reports Bookland data (starting with either 978 or 979) as EAN-13 in 13-digit format to meet the 2007 ISBN-13 protocol.



*Bookland ISBN-10
(00h)



Bookland ISBN-13
(01h)



NOTE For Bookland EAN to function properly, first enable Bookland EAN using [Enable/Disable Bookland EAN on page 8-7](#), then select either Decode UPC/EAN Supplementals, Autodiscriminate UPC/EAN Supplementals, or Enable 978/979 Supplemental Mode in [Decode UPC/EAN/JAN Supplementals on page 8-8](#).

UCC Coupon Extended Code

When enabled, this parameter decodes UPCA bar codes starting with digit '5', EAN-13 bar codes starting with digit '99', and UPCA/EAN-128 Coupon Codes. UPCA, EAN-13 and EAN-128 must be enabled to scan all types of Coupon Codes.



Enable UCC Coupon Extended Code



***Disable UCC Coupon Extended Code**



NOTE Use the *Decode UPC/EAN Supplemental Redundancy* parameter to control autodiscrimination of the EAN128 (right half) of a coupon code.

Code 128

Enable/Disable Code 128

To enable or disable Code 128, scan the appropriate bar code below.

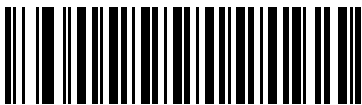

***Enable Code 128**



Disable Code 128

Enable/Disable GS1-128 (formerly UCC/EAN-128)

To enable or disable GS1-128, scan the appropriate bar code below.

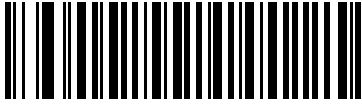

***Enable GS1-128**

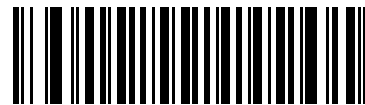

Disable GS1-128

Enable/Disable ISBT 128

ISBT 128 is a variant of Code 128 used in the blood bank industry. Scan the appropriate bar code below to enable or disable ISBT 128. If necessary, the host must perform concatenation of the ISBT data.

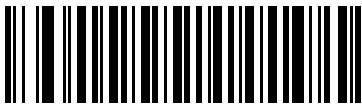

***Enable ISBT 128**



Disable ISBT 128

Code 39

Enable/Disable Code 39

To enable or disable Code 39, scan the appropriate bar code below.

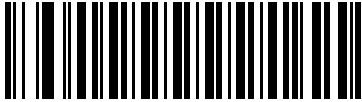

***Enable Code 39**

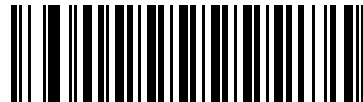

Disable Code 39

Enable/Disable Trioptic Code 39

Trioptic Code 39 is a variant of Code 39 used in the marking of computer tape cartridges. Trioptic Code 39 symbols always contain six characters. To enable or disable Trioptic Code 39, scan the appropriate bar code below.

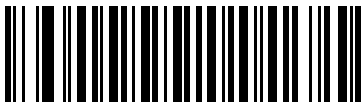

Enable Trioptic Code 39



***Disable Trioptic Code 39**



NOTE Trioptic Code 39 and Code 39 Full ASCII cannot be enabled simultaneously.

Convert Code 39 to Code 32

Code 32 is a variant of Code 39 used by the Italian pharmaceutical industry. Scan the appropriate bar code below to enable or disable converting Code 39 to Code 32.

✓ **NOTE** Code 39 must be enabled for this parameter to function.

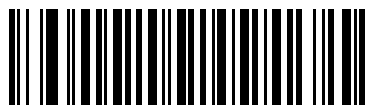

Enable Convert Code 39 to Code 32

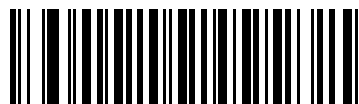

***Disable Convert Code 39 to Code 32**

Code 32 Prefix

Scan the appropriate bar code below to enable or disable adding the prefix character "A" to all Code 32 bar codes.

✓ **NOTE** Convert Code 39 to Code 32 must be enabled for this parameter to function.



Enable Code 32 Prefix



***Disable Code 32 Prefix**

Set Lengths for Code 39

The length of a code refers to the number of characters (i.e., human readable characters), including check digit(s) the code contains. Set lengths for Code 39 to any length, one or two discrete lengths, or lengths within a specific range. If Code 39 Full ASCII is enabled, **Length Within a Range** or **Any Length** are the preferred options.

- ✓ **NOTE** When setting lengths for different bar code types by scanning single digit numbers, single digit numbers must always be preceded by a leading zero.
- **One Discrete Length** - Select this option to decode only Code 39 symbols containing a selected length. Select the length using the numeric bar codes in [Appendix D, Numeric Bar Codes](#). For example, to decode only Code 39 symbols with 14 characters, scan **Code 39 - One Discrete Length**, then scan **1** followed by **4**. To correct an error or change the selection, scan **Cancel** on [page D-3](#).
 - **Two Discrete Lengths** - Select this option to decode only Code 39 symbols containing either of two selected lengths. Select lengths using the numeric bar codes in [Appendix D, Numeric Bar Codes](#). For example, to decode only those Code 39 symbols containing either 2 or 14 characters, select **Code 39 - Two Discrete Lengths**, then scan **0**, **2**, **1**, and then **4**. To correct an error or change the selection, scan **Cancel** on [page D-3](#).
 - **Length Within Range** - Select this option to decode a Code 39 symbol with a specific length range. Select lengths using numeric bar codes in [Appendix D, Numeric Bar Codes](#). For example, to decode Code 39 symbols containing between 4 and 12 characters, first scan **Code 39 - Length Within Range**. Then scan **0**, **4**, **1**, and **2** (single digit numbers must always be preceded by a leading zero). To correct an error or change the selection, scan **Cancel** on [page D-3](#).
 - **Any Length** - Select this option to decode Code 39 symbols containing any number of characters within the scanner capability.



Code 39 - One Discrete Length



Code 39 - Two Discrete Lengths



Code 39 - Length Within Range



Code 39 - Any Length

Code 39 Check Digit Verification

When this feature is enabled, the scanner checks the integrity of all Code 39 symbols to verify that the data complies with specified check digit algorithm. Only Code 39 symbols which include a modulo 43 check digit are decoded. Enable this feature if the Code 39 symbols contain a Modulo 43 check digit.



Enable Code 39 Check Digit



*Disable Code 39 Check Digit

Transmit Code 39 Check Digit

Scan the appropriate bar code below to transmit Code 39 data with or without the check digit.

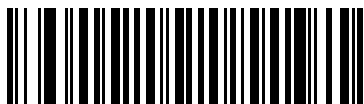

Transmit Code 39 Check Digit
(Enable)



*Do Not Transmit Code 39 Check Digit
(Disable)



NOTE Code 39 Check Digit Verification must be enabled for this parameter to function.

Code 39 Full ASCII Conversion

Code 39 Full ASCII is a variant of Code 39 which pairs characters to encode the full ASCII character set. To enable or disable Code 39 Full ASCII, scan the appropriate bar code below.

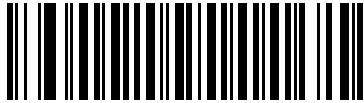

Enable Code 39 Full ASCII

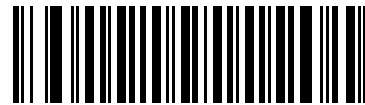

***Disable Code 39 Full ASCII**



NOTE Trioptic Code 39 and Code 39 Full ASCII cannot be enabled simultaneously.

Code 39 Full ASCII to Full ASCII Correlation is host-dependent and is described in the ASCII Character Set table for the appropriate interface. See [ASCII Character Set for Keyboard Wedge on page 5-12](#), [ASCII Character Set for RS-232 on page 6-17](#) and [ASCII Character Set for USB on page 7-11](#) for the appropriate interface.

Code 39 Buffering (Scan & Store)

This feature allows the scanner to accumulate data from multiple Code 39 symbols.

Selecting the Scan and Store option (Buffer Code 39) temporarily buffers all Code 39 symbols having a leading space as a first character for later transmission. The leading space is not buffered.

Decode of a valid Code 39 symbol with no leading space causes transmission in sequence of all buffered data in a first-in first-out format, plus transmission of the “triggering” symbol. See the following pages for further details.

When the **Do Not Buffer Code 39** option is selected, all decoded Code 39 symbols are transmitted immediately without being stored in the buffer.

Code 39 Buffering (Scan & Store) (continued)

This feature affects Code 39 only. If selecting **Buffer Code 39**, we recommend configuring the scanner to decode Code 39 symbology only.



**Buffer Code 39
(Enable)**

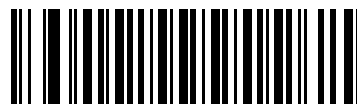

***Do Not Buffer Code 39
(Disable)**

While there is data in the transmission buffer, selecting **Do Not Buffer Code 39** is not allowed. The buffer holds 200 bytes of information.

To disable Code 39 buffering when there is data in the transmission buffer, first force the buffer transmission (see [Transmit Buffer on page 8-26](#)) or clear the buffer.

Buffer Data

To buffer data, Code 39 buffering must be enabled and a Code 39 symbol must be read with a space immediately following the start pattern.

- Unless the data overflows the transmission buffer, the scanner issues a low/high beep to indicate successful decode and buffering. (For overflow conditions, see [Overfilling Transmission Buffer on page 8-26](#).)
- The scanner adds the decoded data excluding the leading space to the transmission buffer.
- No transmission occurs.

Clear Transmission Buffer

To clear the transmission buffer, scan the **Clear Buffer** bar code below, which contains only a start character, a dash (minus), and a stop character.

- The scanner issues a short high/low/high beep.
- The scanner erases the transmission buffer.
- No transmission occurs.



Clear Buffer

- ✓ **NOTE** Because the Clear Buffer contains only the dash (minus) character, set the Code 39 length to include length 1 before scanning this bar code.

Transmit Buffer

There are two methods to transmit the Code 39 buffer.

1. Scan the **Transmit Buffer** bar code below which contains only a start character, a plus (+), and a stop character.
 - The scanner transmits and clears the buffer.
 - The scanner issues a low/high beep.



Transmit Buffer

2. Scan a Code 39 bar code with a leading character other than a space.
 - The scanner appends new decode data to buffered data.
 - The scanner transmits and clears the buffer.
 - The scanner signals that the buffer was transmitted with a low/high beep.
 - Scanner transmits and clears the buffer.

- ✓ **NOTE** Because the Transmit Buffer contains only a plus (+) character, set the Code 39 length to include length 1 before scanning this bar code.

Overfilling Transmission Buffer

The Code 39 buffer holds 200 characters. If the symbol just read results in an overflow of the transmission buffer:

- The scanner indicates that the symbol was rejected by issuing three long, high beeps.
- No transmission occurs. The data in the buffer is not affected.

Attempt to Transmit an Empty Buffer

If the symbol just read was the **Transmit Buffer** symbol and the Code 39 buffer is empty:

- A short low/high/low beep signals that the buffer is empty.
- No transmission occurs.
- The buffer remains empty.

Code 93

Enable/Disable Code 93

To enable or disable Code 93, scan the appropriate bar code below.



Enable Code 93

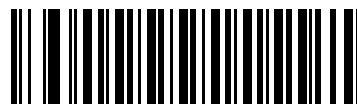

*Disable Code 93

Set Lengths for Code 93

The length of a code refers to the number of characters (i.e., human readable characters), including check digit(s) the code contains. Set lengths for Code 93 to any length, one or two discrete lengths, or lengths within a specific range.

- One Discrete Length** - Select this option to decode only Code 93 symbols containing a selected length. Select the length using the numeric bar codes in [Appendix D, Numeric Bar Codes](#). For example, to decode only Code 93 symbols with 14 characters, scan **Code 93 - One Discrete Length**, then scan **1** followed by **4**. To correct an error or to change the selection, scan **Cancel** on [page D-3](#).
- Two Discrete Lengths** - Select this option to decode only Code 93 symbols containing either of two selected lengths. Select lengths using the numeric bar codes in [Appendix D, Numeric Bar Codes](#). For example, to decode only those Code 93 symbols containing either 2 or 14 characters, select **Code 93 - Two Discrete Lengths**, then scan **0, 2, 1**, and then **4**. To correct an error or to change the selection, scan **Cancel** on [page D-3](#).
- Length Within Range** - Select this option to decode a Code 93 symbol with a specific length range. Select lengths using the numeric bar codes in [Appendix D, Numeric Bar Codes](#). For example, to decode Code 93 symbols containing between 4 and 12 characters, first scan **Code 93 - Length Within Range**. Then scan **0, 4, 1**, and **2** (single digit numbers must always be preceded by a leading zero). To correct an error or change the selection, scan **Cancel** on [page D-3](#).
- Any Length** - Scan this option to decode Code 93 symbols containing any number of characters within the scanner's capability.

Set Lengths for Code 93 (continued)



Code 93 - One Discrete Length



Code 93 - Two Discrete Lengths



Code 93 - Length Within Range



Code 93 - Any Length

Code 11

Code 11

To enable or disable Code 11, scan the appropriate bar code below.

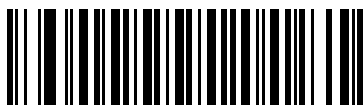

Enable Code 11



*Disable Code 11

Set Lengths for Code 11

The length of a code refers to the number of characters (i.e., human readable characters), including check digit(s) the code contains. Set lengths for Code 11 to any length, one or two discrete lengths, or lengths within a specific range.

- **One Discrete Length** - Select this option to decode only Code 11 symbols containing a selected length. Select the length using the numeric bar codes in [Appendix D, Numeric Bar Codes](#). For example, to decode only Code 11 symbols with 14 characters, scan **Code 11 - One Discrete Length**, then scan **1** followed by **4**. To correct an error or to change the selection, scan **Cancel** on [page D-3](#).
- **Two Discrete Lengths** - Select this option to decode only Code 11 symbols containing either of two selected lengths. Select lengths using the numeric bar codes in [Appendix D, Numeric Bar Codes](#). For example, to decode only those Code 11 symbols containing either 2 or 14 characters, select **Code 11 - Two Discrete Lengths**, then scan **0, 2, 1**, and then **4**. To correct an error or to change the selection, scan **Cancel** on [page D-3](#).
- **Length Within Range** - Select this option to decode a Code 11 symbol with a specific length range. Select lengths using numeric bar codes in [Appendix D, Numeric Bar Codes](#). For example, to decode Code 11 symbols containing between 4 and 12 characters, first scan **Code 11 - Length Within Range**. Then scan **0, 4, 1**, and **2** (single digit numbers must always be preceded by a leading zero). To correct an error or change the selection, scan **Cancel** on [page D-3](#).
- **Any Length** - Scan this option to decode Code 11 symbols containing any number of characters within the scanner capability.



Code 11 - One Discrete Length



Code 11 - Two Discrete Lengths



Code 11 - Length Within Range



Code 11 - Any Length

Code 11 Check Digit Verification

This feature allows the scanner to check the integrity of all Code 11 symbols to verify that the data complies with the specified check digit algorithm. This selects the check digit mechanism for the decoded Code 11 bar code. The options are to check for one check digit, check for two check digits, or disable the feature.

To enable this feature, scan the bar code below corresponding to the number of check digits encoded in your Code 11 symbols.

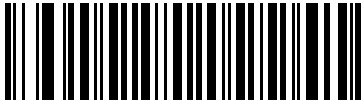

***Disable**

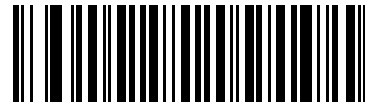

One Check Digit

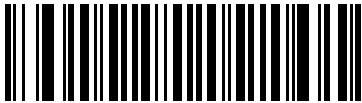

Two Check Digits

Transmit Code 11 Check Digits

This feature selects whether or not to transmit the Code 11 check digit(s).



**Transmit Code 11 Check Digit(s)
(Enable)**



***Do Not Transmit Code 11 Check Digit(s)
(Disable)**

✓ **NOTE** Code 11 Check Digit Verification must be enabled for this parameter to function.

Interleaved 2 of 5 (ITF)

Enable/Disable Interleaved 2 of 5

To enable or disable Interleaved 2 of 5, scan the appropriate bar code below, and select an Interleaved 2 of 5 length from the following pages.



*Enable Interleaved 2 of 5

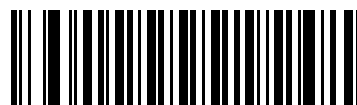

Disable Interleaved 2 of 5

Set Lengths for Interleaved 2 of 5

The length of a code refers to the number of characters (i.e., human readable characters), including check digit(s) the code contains. Set lengths for I 2 of 5 to any length, one or two discrete lengths, or lengths within a specific range.

- **One Discrete Length** - Select this option to decode only I 2 of 5 symbols containing a selected length. Select the length using the numeric bar codes in [Appendix D, Numeric Bar Codes](#). For example, to decode only I 2 of 5 symbols with 14 characters, scan **I 2 of 5 - One Discrete Length**, then scan **1** followed by **4**. To correct an error or to change the selection, scan **Cancel** on [page D-3](#).
- **Two Discrete Lengths** - Select this option to decode only I 2 of 5 symbols containing either of two selected lengths. Select lengths using the numeric bar codes in [Appendix D, Numeric Bar Codes](#). For example, to decode only those I 2 of 5 symbols containing either 2 or 14 characters, select **I 2 of 5 - Two Discrete Lengths**, then scan **0, 2, 1**, and then **4**. To correct an error or to change the selection, scan **Cancel** on [page D-3](#).
- **Length Within Range** - Select this option to decode an I 2 of 5 symbol with a specific length range. Select lengths using numeric bar codes in [Appendix D, Numeric Bar Codes](#). For example, to decode I 2 of 5 symbols containing between 4 and 12 characters, first scan **I 2 of 5 - Length Within Range**. Then scan **0, 4, 1**, and **2** (single digit numbers must always be preceded by a leading zero). To correct an error or change the selection, scan **Cancel** on [page D-3](#).
- **Any Length** - Scan this option to decode I 2 of 5 symbols containing any number of characters within the scanner capability.

✓ **NOTE** Due to the construction of the I 2 of 5 symbology, it is possible for a scan line covering only a portion of the code to be interpreted as a complete scan, yielding less data than is encoded in the bar code. To prevent this, select specific lengths (**I 2 of 5 - One Discrete Length - Two Discrete Lengths**) for I 2 of 5 applications.

Set Lengths for Interleaved 2 of 5 (continued)



I 2 of 5 - One Discrete Length

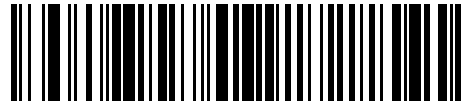

I 2 of 5 - Two Discrete Lengths

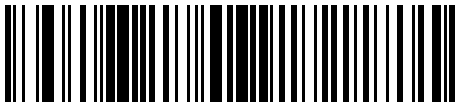

I 2 of 5 - Length Within Range

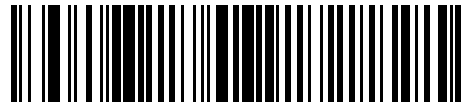

I 2 of 5 - Any Length

I 2 of 5 Check Digit Verification

When this feature is enabled, the scanner checks the integrity of all I 2 of 5 symbols to verify the data complies with either the specified Uniform Symbology Specification (USS), or the Optical Product Code Council (OPCC) check digit algorithm.



***Disable**



USS Check Digit



OPCC Check Digit

Transmit I 2 of 5 Check Digit

Scan the appropriate bar code below to transmit I 2 of 5 data with or without the check digit.

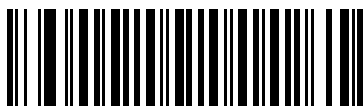

**Transmit I 2 of 5 Check Digit
(Enable)**

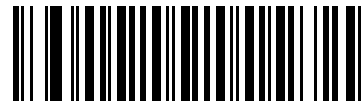

***Do Not Transmit I 2 of 5 Check Digit
(Disable)**

Convert I 2 of 5 to EAN-13

Enable this parameter to convert 14-character I 2 of 5 codes to EAN-13, and transmit to the host as EAN-13. To accomplish this, the I 2 of 5 code must be enabled, and the code must have a leading zero and a valid EAN-13 check digit.

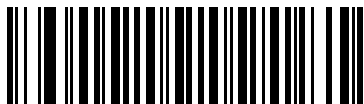

**Convert I 2 of 5 to EAN-13
(Enable)**



***Do Not Convert I 2 of 5 to EAN-13
(Disable)**

Discrete 2 of 5 (DTF)

Enable/Disable Discrete 2 of 5

To enable or disable Discrete 2 of 5, scan the appropriate bar code below.



Enable Discrete 2 of 5



***Disable Discrete 2 of 5**

Set Lengths for Discrete 2 of 5

The length of a code refers to the number of characters (i.e., human readable characters), including check digit(s) the code contains. Set lengths for D 2 of 5 to any length, one or two discrete lengths, or lengths within a specific range.

- **One Discrete Length** - Select this option to decode only D 2 of 5 symbols containing a selected length. Select the length using the numeric bar codes in [Appendix D, Numeric Bar Codes](#). For example, to decode only D 2 of 5 symbols with 14 characters, scan **D 2 of 5 - One Discrete Length**, then scan **1** followed by **4**. To correct an error or to change the selection, scan **Cancel** on [page D-3](#).
- **Two Discrete Lengths** - Select this option to decode only D 2 of 5 symbols containing either of two selected lengths. Select lengths using the numeric bar codes in [Appendix D, Numeric Bar Codes](#). For example, to decode only those D 2 of 5 symbols containing either 2 or 14 characters, select **D 2 of 5 - Two Discrete Lengths**, then scan **0, 2, 1**, and then **4**. To correct an error or to change the selection, scan **Cancel** on [page D-3](#).
- **Length Within Range** - Select this option to decode a D 2 of 5 symbol with a specific length range. Select lengths using numeric bar codes in [Appendix D, Numeric Bar Codes](#). For example, to decode D 2 of 5 symbols containing between 4 and 12 characters, first scan **D 2 of 5 - Length Within Range**. Then scan **0, 4, 1**, and **2** (single digit numbers must always be preceded by a leading zero). To correct an error or change the selection, scan **Cancel** on [page D-3](#).
- **Any Length** - Scan this option to decode D 2 of 5 symbols containing any number of characters within the scanner capability.

✓ **NOTE** Due to the construction of the D 2 of 5 symbology, it is possible for a scan line covering only a portion of the code to be interpreted as a complete scan, yielding less data than is encoded in the bar code. To prevent this, select specific lengths (**D 2 of 5 - One Discrete Length - Two Discrete Lengths**) for D 2 of 5 applications.



D 2 of 5 - One Discrete Length



D 2 of 5 - Two Discrete Lengths



D 2 of 5 - Length Within Range



D 2 of 5 - Any Length

Chinese 2 of 5

Enable/Disable Chinese 2 of 5

To enable or disable Chinese 2 of 5, scan the appropriate bar code below.



Enable Chinese 2 of 5



*Disable Chinese 2 of 5

Codabar (NW - 7)

Enable/Disable Codabar

To enable or disable Codabar, scan the appropriate bar code below.



Enable Codabar



*Disable Codabar

Set Lengths for Codabar

The length of a code refers to the number of characters (i.e., human readable characters), including check digit(s) the code contains. Set lengths for Codabar to any length, one or two discrete lengths, or lengths within a specific range.

- One Discrete Length** - Select this option to decode only Codabar symbols containing a selected length. Select the length using the numeric bar codes in [Appendix D, Numeric Bar Codes](#). For example, to decode only Codabar symbols with 14 characters, scan **Codabar - One Discrete Length**, then scan **1** followed by **4**. To correct an error or to change the selection, scan **Cancel** on [page D-3](#).
- Two Discrete Lengths** - Select this option to decode only Codabar symbols containing either of two selected lengths. Select lengths using the numeric bar codes in [Appendix D, Numeric Bar Codes](#). For example, to decode only Codabar symbols containing either 2 or 14 characters, select **Codabar - Two Discrete Lengths**, then scan **0, 2, 1**, and then **4**. To correct an error or to change the selection, scan **Cancel** on [page D-3](#).
- Length Within Range** - Select this option to decode a Codabar symbol with a specific length range. Select lengths using numeric bar codes in [Appendix D, Numeric Bar Codes](#). For example, to decode Codabar symbols containing between 4 and 12 characters, first scan **Codabar - Length Within Range**. Then scan **0, 4, 1**, and **2** (single digit numbers must always be preceded by a leading zero). To correct an error or change the selection, scan **Cancel** on [page D-3](#).
- Any Length** - Scan this option to decode Codabar symbols containing any number of characters within the scanner capability.



Codabar - One Discrete Length



Codabar - Two Discrete Lengths



Codabar - Length Within Range



Codabar - Any Length

CLSI Editing

When enabled, this parameter strips the start and stop characters and inserts a space after the first, fifth, and tenth characters of a 14-character Codabar symbol. Enable this feature if your host system requires this data format.

✓ **NOTE** Symbol length does not include start and stop characters.



Enable CLSI Editing

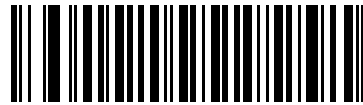

*Disable CLSI Editing

NOTIS Editing

When enabled, this parameter strips the start and stop characters from a decoded Codabar symbol. Enable this feature if your host system requires this data format.

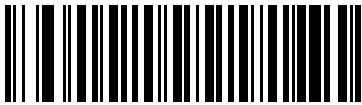

Enable NOTIS Editing



*Disable NOTIS Editing

MSI

Enable/Disable MSI

To enable or disable MSI, scan the appropriate bar code below.

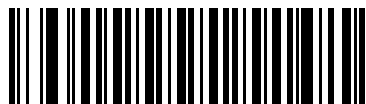

Enable MSI



*Disable MSI

Set Lengths for MSI

The length of a code refers to the number of characters (i.e., human readable characters), including check digit(s) the code contains. Set lengths for MSI to any length, one or two discrete lengths, or lengths within a specific range.

- **One Discrete Length** - Select this option to decode only MSI symbols containing a selected length. Select the length using the numeric bar codes in [Appendix D, Numeric Bar Codes](#). For example, to decode only MSI symbols with 14 characters, scan **MSI - One Discrete Length**, then scan **1** followed by **4**. To correct an error or to change the selection, scan **Cancel** on [page D-3](#).
- **Two Discrete Lengths** - Select this option to decode only MSI symbols containing either of two selected lengths. Select lengths using the numeric bar codes in [Appendix D, Numeric Bar Codes](#). For example, to decode only MSI symbols containing either 2 or 14 characters, select **MSI - Two Discrete Lengths**, then scan **0, 2, 1**, and then **4**. To correct an error or to change the selection, scan **Cancel** on [page D-3](#).
- **Length Within Range** - Select this option to decode a MSI symbol with a specific length range. Select lengths using numeric bar codes in [Appendix D, Numeric Bar Codes](#). For example, to decode MSI symbols containing between 4 and 12 characters, first scan **MSI - Length Within Range**. Then scan **0, 4, 1**, and **2** (single digit numbers must always be preceded by a leading zero). To correct an error or change the selection, scan **Cancel** on [page D-3](#).
- **Any Length** - Scan this option to decode MSI symbols containing any number of characters within the scanner capability.

✓ **NOTE** Due to the construction of the MSI symbology, it is possible for a scan line covering only a portion of the code to be interpreted as a complete scan, yielding less data than is encoded in the bar code. To prevent this, select specific lengths (**MSI - One Discrete Length - Two Discrete Lengths**) for MSI applications.

Set Lengths for MSI (continued)



MSI - One Discrete Length



MSI - Two Discrete Lengths

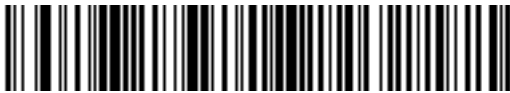

MSI - Length Within Range



MSI - Any Length

MSI Check Digits

With MSI symbols, one check digit is mandatory and always verified by the reader. The second check digit is optional. If the MSI codes include two check digits, scan the **Two MSI Check Digits** bar code to enable verification of the second check digit.

See [MSI Check Digit Algorithm on page 8-41](#) for the selection of second digit algorithms.

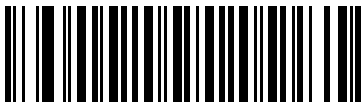

*One MSI Check Digit

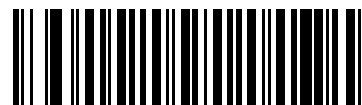

Two MSI Check Digits

Transmit MSI Check Digit(s)

Scan the appropriate bar code below to transmit MSI data with or without the check digit.

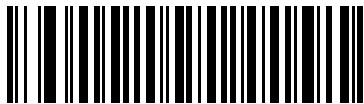

**Transmit MSI Check Digit(s)
(Enable)**



***Do Not Transmit MSI Check Digit(s)
(Disable)**

MSI Check Digit Algorithm

Two algorithms are possible for the verification of the second MSI check digit. Select the bar code below corresponding to the algorithm used to encode your check digit.

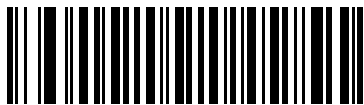

MOD 11/MOD 10



***MOD 10/MOD 10**

GS1 DataBar (formerly RSS, Reduced Space Symbology)

The variants of GS1 DataBar are GS1 DataBar Omnidirectional (formerly GS1 DataBar-14), GS1 DataBar Expanded and GS1 DataBar Limited. GS1 DataBar Omnidirectional (formerly GS1 DataBar-14) and GS1 DataBar Expanded include stacked versions. Scan the appropriate bar code below to enable or disable each variant of GS1 DataBar.

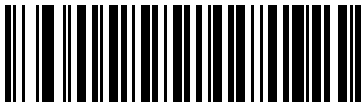

Enable GS1 DataBar Omnidirectional

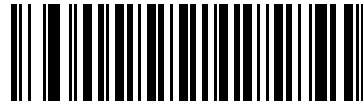

***Disable GS1 DataBar Omnidirectional**

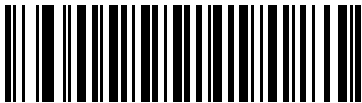

Enable GS1 DataBar Limited

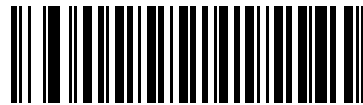

***Disable GS1 DataBar Limited**

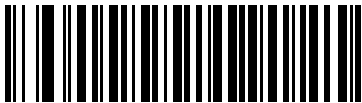

Enable GS1 DataBar Expanded

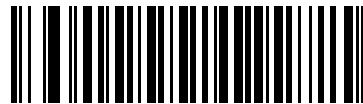

***Disable GS1 DataBar Expanded**

Convert GS1 DataBar to UPC/EAN

This parameter only applies to GS1 DataBar Omnidirectional (formerly GS1 DataBar-14) and GS1 DataBar Limited symbols not decoded as part of a Composite symbol. Enable this to strip the leading '010' from GS1 DataBar Omnidirectional (formerly GS1 DataBar-14) and GS1 DataBar Limited symbols encoding a single zero as the first digit, and report the bar code as EAN-13.

For bar codes beginning with two or more zeros but not six zeros, this parameter strips the leading '0100' and reports the bar code as UPC-A. The UPC-A Preamble parameter that transmits the system character and country code applies to converted bar codes. Note that neither the system character nor the check digit can be stripped.

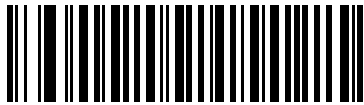

Enable Convert GS1 DataBar to UPC/EAN

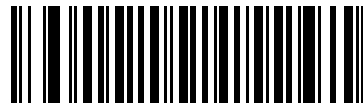

***Disable Convert GS1 DataBar to UPC/EAN**

Symbology - Specific Security Levels

Redundancy Level

The scanner offers four levels of decode redundancy. Select higher redundancy levels for decreasing levels of bar code quality. As redundancy levels increase, the scanner's aggressiveness decreases.

Select the redundancy level appropriate for the bar code quality.

Redundancy Level 1

The following code types must be successfully read twice before being decoded:

Table 8-2 *Redundancy Level 1 Code Types*

Code Type	Code Length
Codabar	8 characters or less
MSI	4 characters or less
D 2 of 5	8 characters or less
I 2 of 5	8 characters or less

Redundancy Level 2

The following code types must be successfully read twice before being decoded:

Table 8-3 *Redundancy Level 2 Code Types*

Code Type	Code Length
All	All

Redundancy Level 3

Code types other than the following must be successfully read twice before being decoded. The following codes must be read three times:

Table 8-4 *Redundancy Level 3 Code Types*

Code Type	Code Length
MSI	4 characters or less
D 2 of 5	8 characters or less
I 2 of 5	8 characters or less
Codabar	8 characters or less

Redundancy Level 4

The following code types must be successfully read three times before being decoded:

Table 8-5 *Redundancy Level 4 Code Types*

Code Type	Code Length
All	All

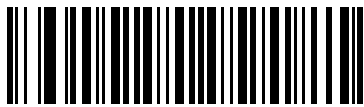
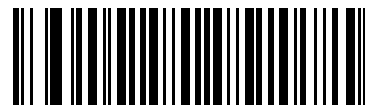
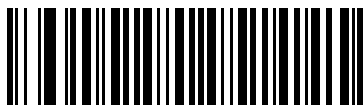
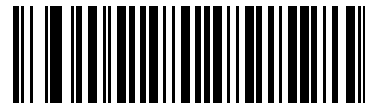
***Redundancy Level 1****Redundancy Level 2****Redundancy Level 3****Redundancy Level 4**

Security Level

The scanner offers four levels of decode security for delta bar codes, which include the Code 128 family, UPC/EAN, and Code 93. Select increasing levels of security for decreasing levels of bar code quality. There is an inverse relationship between security and scanner aggressiveness, so choose only that level of security necessary for any given application.

- **Security Level 0:** This default setting allows the scanner to operate in its most aggressive state, while providing sufficient security in decoding most “in-spec” bar codes.
- **Security Level 1:** Select this option if misdecodes occur. This security level should eliminate most misdecodes.
- **Security Level 2:** Select this option if Security level 1 fails to eliminate misdecodes.
- **Security Level 3:** If Security Level 2 was selected and misdecodes still occur, select this security level. Be advised, selecting this option is an extreme measure against mis-decoding severely out of spec bar codes. Selecting this level of security significantly impairs the decoding ability of the scanner. If this level of security is necessary, try to improve the quality of the bar codes.

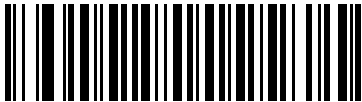

***Security Level 0**

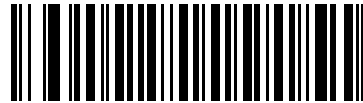

Security Level 1

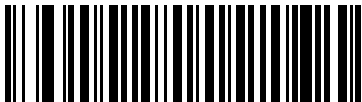

Security Level 2



Security Level 3

Bi-directional Redundancy

Enable Bi-directional Redundancy to add security to linear code type security levels. When enabled, a bar code must be successfully scanned in both directions (forward and reverse) before reporting a good decode.



Enable Bi-directional Redundancy

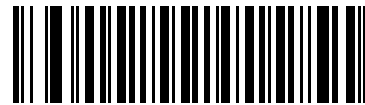

*Disable Bi-directional Redundancy

Symbology - Intercharacter Gap

The Code 39 and Codabar symbologies have an intercharacter gap that is customarily quite small. Due to various bar code printing technologies, this gap may grow larger than the maximum size allowed, causing the scanner to be unable to decode the symbol. If this problem is encountered, scan **Large Intercharacter Gaps** to tolerate out-of-specification bar codes.



*Normal Intercharacter Gaps



Large Intercharacter Gaps

Chapter 9 123Scan

Introduction

This chapter briefly describes the Zebra software tools available for customizing scanner operation.

123Scan

123Scan is a software tool that simplifies scanner setup and more.

Intuitive enough for first time users, the 123Scan wizard guides users through a streamlined setup process. Settings are saved in a configuration file that can be printed as a single programming bar code for scanning, emailed to a smart phone for scanning from its screen, or downloaded to the scanner using a USB cable.

Through 123Scan a user can accomplish the following.

- Configure a scanner using a wizard.
- Program the following scanner settings:
 - Beeper tone / volume settings.
 - Enable / disable symbologies.
 - Communication settings.
- Modify data before transmission to a host using:
 - Advanced Data Formatting (ADF) - Scan one bar code per trigger pull.
- Load parameter settings to a scanner via:
 - Bar code scanning.
 - Scan a paper bar code.
 - Scan a bar code from a PC screen.
 - Scan a bar code from a smart phone screen.
- Download over a USB cable:
 - Load settings to one scanner.

- Validate scanner setup:
 - View scanned data within the utility's Data View screen.
 - Review settings using the Parameter Report.
 - Clone settings from an already deployed scanner from the start screen.
- Upgrade scanner firmware:
 - One unit at a time using a USB cable.
- Generate the following reports:
 - Bar Code Report - Programming bar code, included parameter settings, and supported scanner models.
 - Parameter Report - Lists parameters programmed within a configuration file.
 - Inventory Report - Lists scanner asset tracking information.
 - Validation Report - Printout of scanned data from the Data view.
 - Statistics Report - Lists all statistics retrieved from the scanner.

For more information go to: www.zebra.com/123Scan.

Communication with 123Scan

Use a USB cable to connect the scanner to a Windows host computer running 123Scan.

123Scan Requirements

- Host computer running Windows XP, 7, 8 and 10
- Scanner
- USB cable.

123Scan Information

For more information on 123Scan, go to: www.zebra.com/123Scan.

For a one minute tour of 123Scan, go to: www.zebra.com/ScannerHowToVideos.

To see a list of all of our software tools, go to: www.zebra.com/scannersoftware.

Scanner SDK, Other Software Tools, and Videos

Tackle all your scanner programming needs with our diversified set of software tools. Whether you need to simply stage a device, or develop a fully featured application with image and data capture as well as asset management, these tools help you every step of the way.

To download any of the free tools listed below, go to: www.zebra.com/software.

- 123Scan configuration utility
- Drivers
 - OPOS driver
 - JPOS driver
 - USB CDC driver
- How-to-Videos

Advanced Data Formatting (ADF)

Advanced Data Formatting (ADF) is a means of customizing data from before transmission to the host device. Use ADF to edit scan data to suit your host application requirements. With ADF you scan one bar code per trigger pull. ADF is programmed using 123Scan.

To watch a video on Creating an Advanced Data Formatting (ADF) Rule using 123Scan, go to: www.zebra.com/ScannerHowToVideos.

For additional information, refer to the Advanced Data Formatting Programmer Guide, p/n 72E-69680-xx.

Appendix A Standard Defaults

Table A-1 All Default Parameters

Parameter	Default	Page Number
User Preferences		
Set Default Parameter	Restore Defaults	4-3
Beeper Tone	Medium	4-4
Beeper Volume	High	4-4
Power Mode	Continuous On	4-5
Scan Line Width	Full Width	4-6
Laser On Time	3.0 Sec	4-6
Beep After Good Decode	Enable	4-7
Transmit Code ID Character	None	4-7
Prefix Value	7013 <CR><LF>	4-8
Suffix Value	7013 <CR><LF>	4-8
Scan Data Transmission Format	Data As Is	4-8
FN1 Substitution Values	Set	4-10
Transmit "No Read" Message	Disable	4-10
Keyboard Wedge Host Parameters		
Keyboard Wedge Host Type	IBM PC/AT& IBM PC Compatibles ¹	5-4
Country Types (Country Codes)	North American	5-5
Ignore Unknown Characters	Send	5-6

¹User selection is required to configure this interface and this is the most common selection.

Table A-1 All Default Parameters (Continued)

Parameter	Default	Page Number
Keystroke Delay	No Delay	5-7
Intra-Keystroke Delay	Disable	5-7
Alternate Numeric Keypad Emulation	Disable	5-8
Caps Lock On	Disable	5-8
Caps Lock Override	Disable	5-9
Convert Wedge Data	No Convert	5-9
Function Key Mapping	Disable	5-10
FN1 Substitution	Disable	5-10
Send and Make Break	Send	5-11
RS-232 Host Parameters		
RS-232 Host Types	Standard	6-6
Baud Rate	9600	6-7
Parity Type	None	6-8
Stop Bit Select	1 Stop Bit	6-9
Data Bits (ASCII Format)	8-Bit	6-9
Check Receive Errors	Enable	6-10
Hardware Handshaking	None	6-10
Software Handshaking	None	6-12
Host Serial Response Time-out	2 Sec	6-13
RTS Line State	Low RTS	6-14
Beep on <BEL>	Disable	6-14
Intercharacter Delay	0 msec	6-15
Nixdorf Beep/LED Options	Normal Operation	6-16
Ignore Unknown Characters	Send Bar Code	6-16
USB Host Parameters		
USB Device Type	USB HID Keyboard	7-4
USB Country Keyboard Types (Country Codes)	North American	7-5
USB Keystroke Delay	No Delay	7-7
USB CAPS Lock Override	Disable	7-7

¹User selection is required to configure this interface and this is the most common selection.

Table A-1 All Default Parameters (Continued)

Parameter	Default	Page Number
USB Ignore Unknown Characters	Send	7-8
Emulate Keypad	Disable	7-8
USB FN1 Substitution	Disable	7-9
Function Key Mapping	Disable	7-9
Simulated Caps Lock	Disable	7-10
Convert Case	No Case Conversion	7-10
UPC/EAN		
UPC-A	Enable	8-5
UPC-E	Enable	8-5
UPC-E1	Disable	8-6
EAN-8/JAN 8	Enable	8-7
EAN-13/JAN 13	Enable	8-7
Bookland EAN	Disable	8-7
Decode UPC/EAN/JAN Supplementals (2 and 5 digits)	Ignore	8-8
User-Programmable Supplementals		8-11
Decode UPC/EAN/JAN Supplemental Redundancy	7	8-11
Transmit UPC-A Check Digit	Enable	8-12
Transmit UPC-E Check Digit	Enable	8-12
Transmit UPC-E1 Check Digit	Enable	8-13
UPC-A Preamble	System Character	8-13
UPC-E Preamble	System Character	8-14
UPC-E1 Preamble	System Character	8-15
Convert UPC-E to A	Disable	8-15
Convert UPC-E1 to A	Disable	8-16
EAN-8/JAN-8 Extend	Disable	8-16
Bookland ISBN Format	ISBN-10	8-17
UCC Coupon Extended Code	Disable	8-18

¹User selection is required to configure this interface and this is the most common selection.

Table A-1 All Default Parameters (Continued)

Parameter	Default	Page Number
Code 128		
Code 128	Enable	8-18
GS1-128 (formerly UCC/EAN-128)	Enable	8-19
ISBT 128 (non-concatenated)	Enable	8-19
Code 39		
Code 39	Enable	8-20
Trioptic Code 39	Disable	8-20
Convert Code 39 to Code 32 (Italian Pharmacy Code)	Disable	8-21
Code 32 Prefix	Disable	8-21
Set Length(s) for Code 39	2 to 55	8-22
Code 39 Check Digit Verification	Disable	8-23
Transmit Code 39 Check Digit	Disable	8-23
Code 39 Full ASCII Conversion	Disable	8-24
Buffer Code 39	Disable	8-24
Code 93		
Code 93	Disable	8-27
Set Length(s) for Code 93	4 to 55	8-27
Code 11		
Code 11	Disable	8-28
Set Lengths for Code 11	4 to 55	8-29
Code 11 Check Digit Verification	Disable	8-30
Transmit Code 11 Check Digit(s)	Disable	8-30
Interleaved 2 of 5 (ITF)		
Interleaved 2 of 5 (ITF)	Enable	8-31
Set Lengths for I 2 of 5	14	8-31
I 2 of 5 Check Digit Verification	Disable	8-33
Transmit I 2 of 5 Check Digit	Disable	8-33
Convert I 2 of 5 to EAN 13	Disable	8-34

¹User selection is required to configure this interface and this is the most common selection.

Table A-1 All Default Parameters (Continued)

Parameter	Default	Page Number
Discrete 2 of 5 (DTF)		
Discrete 2 of 5	Disable	8-34
Set Length(s) for D 2 of 5	12	8-35
Chinese 2 of 5		
Enable/Disable Chinese 2 of 5	Disable	8-36
Codabar (NW - 7)		
Codabar	Disable	8-36
Set Lengths for Codabar	5 to 55	8-37
CLSI Editing	Disable	8-38
NOTIS Editing	Disable	8-38
MSI		
MSI	Disable	8-39
Set Length(s) for MSI	2 to 55	8-39
MSI Check Digits	One	8-40
Transmit MSI Check Digit	Disable	8-41
MSI Check Digit Algorithm	Mod 10/Mod 10	8-41
GS1 DataBar (formerly RSS, Reduced Space Symbology)		
GS1 DataBar Omnidirectional (formerly GS1 DataBar-14)	Disable	8-42
GS1 DataBar Limited	Disable	8-42
GS1 DataBar Expanded	Disable	8-42
Convert GS1 DataBar to UPC/EAN	Disable	8-43
Symbology - Specific Security Levels		
Redundancy Level	1	8-44
Security Levels	0	8-46
Bi-directional Redundancy	Disable	8-47
123Scan Configuration Tool		
123Scan Configuration	None ¹	9-1

¹User selection is required to configure this interface and this is the most common selection.

Appendix B Programming Reference

Symbol Code Identifiers

Table B-1 *Symbol Code Characters*

Code Character	Code Type
A	UPC-A, UPC-E, UPC-E1, EAN-8, EAN-13
B	Code 39, Code 39 Full ASCII, Code 32
C	Codabar
D	Code 128, ISBT 128
E	Code 93
F	Interleaved 2 of 5
G	Discrete 2 of 5, or Discrete 2 of 5 IATA
H	Code 11
J	MSI
K	GS1-128
L	Bookland EAN
M	Trioptic Code 39
N	Coupon Code
R	GS1 DataBar Family

AIM Code Identifiers

Each AIM Code Identifier contains the three-character string **Jcm** where:

- J = Flag Character (ASCII 93)
- c = Code Character (see [Table B-2](#))
- m = Modifier Character (see [Table B-3](#))

Table B-2 Aim Code Characters

Code Character	Code Type
A	Code 39, Code 39 Full ASCII, Code 32
C	Code 128 (all variants), Coupon (Code 128 portion)
E	UPC/EAN, Coupon (UPC portion)
e	GS1 DataBar Family
F	Codabar
G	Code 93
H	Code 11
I	Interleaved 2 of 5
M	MSI
S	D2 of 5, IATA 2 of 5
X	Bookland EAN, Trioptic Code 39

The modifier character is the sum of the applicable option values based on [Table B-3](#).

Table B-3 Modifier Characters

Code Type	Option Value	Option
Code 39	0	No check character or Full ASCII processing.
	1	Reader has checked one check character.
	3	Reader has checked and stripped check character.
	4	Reader has performed Full ASCII character conversion.
	5	Reader has performed Full ASCII character conversion and checked one check character.
	7	Reader has performed Full ASCII character conversion and checked and stripped check character.
Example: A Full ASCII bar code with check character W, A+I+MI+DW , is transmitted as JA7AIMID where 7 = (3+4).		

Table B-3 *Modifier Characters (Continued)*

Code Type	Option Value	Option
Trioptic Code 39	0	No option specified at this time. Always transmit 0.
	Example: A Trioptic bar code 412356 is transmitted as JX0412356	
Code 128	0	Standard data packet, no Function code 1 in first symbol position.
	1	Function code 1 in first symbol character position.
	2	Function code 1 in second symbol character position.
	Example: A Code (EAN) 128 bar code with Function 1 character FNC1 in the first position, AIMID is transmitted as JC1AIMID	
I 2 of 5	0	No check digit processing.
	1	Reader has validated check digit.
	3	Reader has validated and stripped check digit.
	Example: An I 2 of 5 bar code without check digit, 4123, is transmitted as J104123	
Codabar	0	No check digit processing.
	1	Reader has checked check digit.
	3	Reader has stripped check digit before transmission.
	Example: A Codabar bar code without check digit, 4123, is transmitted as JF04123	
Code 93	0	No options specified at this time. Always transmit 0.
	Example: A Code 93 bar code 012345678905 is transmitted as JG0012345678905	
MSI	0	Check digits are sent.
	1	No check digit is sent.
	Example: An MSI bar code 4123, with a single check digit checked, is transmitted as JM14123	
D 2 of 5	0	No options specified at this time. Always transmit 0.
	Example: A D 2 of 5 bar code 4123, is transmitted as JS04123	
UPC/EAN	0	Standard packet in full EAN country code format, which is 13 digits for UPC-A and UPC-E (not including supplemental data).
	1	Two-digit supplement data only.
	2	Five-digit supplement data only.
	4	EAN-8 data packet.
	Example: A UPC-A bar code 012345678905 is transmitted as JE00012345678905	

Table B-3 *Modifier Characters (Continued)*

Code Type	Option Value	Option
Bookland EAN	0	No options specified at this time. Always transmit 0.
	Example: A Bookland EAN bar code 123456789X is transmitted as JX0 123456789X	
Code 11	0	Single check digit
	1	Two check digits
	3	Check characters validated but not transmitted.
GS1 DataBar Family		No option specified at this time. Always transmit 0. GS1 DataBar Omnidirectional (formerly GS1 DataBar-14) and GS1 DataBar Limited transmit with an Application Identifier "01". Note: In GS1-128 emulation mode, GS1 DataBar is transmitted using Code 128 rules (i.e., Jc1).
	Example: A GS1 DataBar Omnidirectional (formerly GS1 DataBar-14) bar code 100123456788902 is transmitted as Je 001100123456788902.	

Appendix C Sample Bar Codes

Code 39



UPC/EAN

UPC-A, 100%

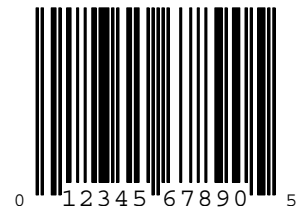

EAN-13, 100%



Code 128



Interleaved 2 of 5



GS1 DataBar

✓ **NOTE** GS1 DataBar variants must be enabled to read the bar codes below (see [GS1 DataBar \(formerly RSS, Reduced Space Symbology\) on page 8-42](#)).



10293847560192837465019283746029478450366523
(GS1 DataBar Expanded Stacked)



1234890hjio9900mnb
(GS1 DataBar Expanded)



08672345650916
(GS1 DataBar Limited)

GS1 DataBar Omnidirectional (formerly GS1 DataBar-14)



55432198673467
(GS1 DataBar Omnidirectional Truncated)



90876523412674
(GS1 DataBar Omnidirectional Stacked)



78123465709811
(GS1 DataBar Omnidirectional Stacked)

Appendix D Numeric Bar Codes

Numeric Bar Codes

For parameters requiring specific numeric values, scan the appropriately numbered bar code(s).



0



1



2



3

Numeric Bar Codes (continued)



4



5



6



7



8



9

Cancel

To correct an error or change a selection, scan the bar code below.



Cancel

Appendix E ASCII Character Sets

Table E-1 ASCII Value - Code 39 Encode - Keystroke

ASCII Value	Full ASCII Code 39 Encode Character	Keystroke
1000	%U	CTRL 2
1001	\$A	CTRL A
1002	\$B	CTRL B
1003	\$C	CTRL C
1004	\$D	CTRL D
1005	\$E	CTRL E
1006	\$F	CTRL F
1007	\$G	CTRL G
1008	\$H	CTRL H/ BACKSPACE ¹
1009	\$I	CTRL I/ HORIZONTAL TAB ¹
1010	\$J	CTRL J
1011	\$K	CTRL K
1012	\$L	CTRL L
1013	\$M	CTRL M/ ENTER ¹
1014	\$N	CTRL N
1015	\$O	CTRL O

The keystroke in bold is sent only if the "Function Key Mapping" is enabled. Otherwise, the unbolded keystroke is sent.

Table E-1 ASCII Value - Code 39 Encode - Keystroke (Continued)

ASCII Value	Full ASCII Code 39 Encode Character	Keystroke
1016	\$P	CTRL P
1017	\$Q	CTRL Q
1018	\$R	CTRL R
1019	\$S	CTRL S
1020	\$T	CTRL T
1021	\$U	CTRL U
1022	\$V	CTRL V
1023	\$W	CTRL W
1024	\$X	CTRL X
1025	\$Y	CTRL Y
1026	\$Z	CTRL Z
1027	%A	CTRL [
1028	%B	CTRL \
1029	%C	CTRL]
1030	%D	CTRL 6
1031	%E	CTRL -
1032	Space	Space
1033	/A	!
1034	/B	“
1035	/C	#
1036	/D	?
1037	/E	%
1038	/F	&
1039	/G	‘
1040	/H	(
1041	/I)
1042	/J	*
1043	/K	+

The keystroke in bold is sent only if the “Function Key Mapping” is enabled. Otherwise, the unbolded keystroke is sent.

Table E-1 ASCII Value - Code 39 Encode - Keystroke (Continued)

ASCII Value	Full ASCII Code 39 Encode Character	Keystroke
1044	/L	,
1045	-	-
1046	.	.
1047	/o	/
1048	0	0
1049	1	1
1050	2	2
1051	3	3
1052	4	4
1053	5	5
1054	6	6
1055	7	7
1056	8	8
1057	9	9
1058	/Z	:
1059	%F	;
1060	%G	<
1061	%H	=
1062	%I	>
1063	%J	?
1064	%V	@
1065	A	A
1066	B	B
1067	C	C
1068	D	D
1069	E	E
1070	F	F
1071	G	G

The keystroke in bold is sent only if the “Function Key Mapping” is enabled. Otherwise, the unbolded keystroke is sent.

Table E-1 ASCII Value - Code 39 Encode - Keystroke (Continued)

ASCII Value	Full ASCII Code 39 Encode Character	Keystroke
1072	H	H
1073	I	I
1074	J	J
1075	K	K
1076	L	L
1077	M	M
1078	N	N
1079	O	O
1080	P	P
1081	Q	Q
1082	R	R
1083	S	S
1084	T	T
1085	U	U
1086	V	V
1087	W	W
1088	X	X
1089	Y	Y
1090	Z	Z
1091	%K	[
1092	%L	\
1093	%M]
1094	%N	^
1095	%O	_
1096	%W	'
1097	+A	a
1098	+B	b
1099	+C	c

The keystroke in bold is sent only if the "Function Key Mapping" is enabled. Otherwise, the unbolded keystroke is sent.

Table E-1 ASCII Value - Code 39 Encode - Keystroke (Continued)

ASCII Value	Full ASCII Code 39 Encode Character	Keystroke
1100	+D	d
1101	+E	e
1102	+F	f
1103	+G	g
1104	+H	h
1105	+I	i
1106	+J	j
1107	+K	k
1108	+L	l
1109	+M	m
1110	+N	n
1111	+O	o
1112	+P	p
1113	+Q	q
1114	+R	r
1115	+S	s
1116	+T	t
1117	+U	u
1118	+V	v
1119	+W	w
1120	+X	x
1121	+Y	y
1122	+Z	z
1123	%P	{
1124	%Q	
1125	%R	}
1126	%S	~

The keystroke in bold is sent only if the "Function Key Mapping" is enabled. Otherwise, the unbolded keystroke is sent.

Table E-2 *ALT Key Standard Defaults*

ALT Keys	Keystroke
2064	ALT 2
2065	ALT A
2066	ALT B
2067	ALT C
2068	ALT D
2069	ALT E
2070	ALT F
2071	ALT G
2072	ALT H
2073	ALT I
2074	ALT J
2075	ALT K
2076	ALT L
2077	ALT M
2078	ALT N
2079	ALT O
2080	ALT P
2081	ALT Q
2082	ALT R
2083	ALT S
2084	ALT T
2085	ALT U
2086	ALT V
2087	ALT W
2088	ALT X
2089	ALT Y
2090	ALT Z

Table E-3 *Miscellaneous Key Standard Defaults*

Misc. Key	Keystroke
3001	PA 1
3002	PA 2
3003	CMD 1
3004	CMD 2
3005	CMD 3
3006	CMD 4
3007	CMD 5
3008	CMD 6
3009	CMD 7
3010	CMD 8
3011	CMD 9
3012	CMD 10
3013	CMD 11
3014	CMD 12
3015	CMD 13
3016	CMD 14

Table E-4 *GUI Shift Keys*

Other Value	Keystroke
3048	GUI 0
3049	GUI 1
3050	GUI 2
3051	GUI 3
3052	GUI 4
3053	GUI 5
3054	GUI 6
3055	GUI 7
3056	GUI 8
3057	GUI 9
3065	GUI A
3066	GUI B
3067	GUI C
3068	GUI D
3069	GUI E
3070	GUI F
3071	GUI G
3072	GUI H
3073	GUI I
3074	GUI J
3075	GUI K
3076	GUI L
3077	GUI M
3078	GUI N
3079	GUI O
3080	GUI P

GUI Shift Keys

The Apple™ iMac keyboard has an apple key on either side of the space bar. Windows-based systems have a GUI key to the left of the left ALT key, and to the right of the right ALT key.

Table E-4 GUI Shift Keys (Continued)

Other Value	Keystroke
3081	GUI Q
3082	GUI R
3083	GUI S
3084	GUI T
3085	GUI U
3086	GUI V
3087	GUI W
3088	GUI X
3089	GUI Y
3090	GUI Z

GUI Shift Keys
The Apple™ iMac keyboard has an apple key on either side of the space bar.
Windows-based systems have a GUI key to the left of the left ALT key, and to the right of the right ALT key.

Table E-5 PF Key Standard Default Table

PF Keys	Keystroke
4001	PF 1
4002	PF 2
4003	PF 3
4004	PF 4
4005	PF 5
4006	PF 6
4007	PF 7
4008	PF 8
4009	PF 9
4010	PF 10
4011	PF 11
4012	PF 12
4013	PF 13

Table E-5 *PF Key Standard Default Table (Continued)*

PF Keys	Keystroke
4014	PF 14
4015	PF 15
4016	PF 16

Table E-6 *F key Standard Default Table*

F Keys	Keystroke
5001	F 1
5002	F 2
5003	F 3
5004	F 4
5005	F 5
5006	F 6
5007	F 7
5008	F 8
5009	F 9
5010	F 10
5011	F 11
5012	F 12
5013	F 13
5014	F 14
5015	F 15
5016	F 16
5017	F 17
5018	F 18
5019	F 19
5020	F 20
5021	F 21

Table E-6 *F key Standard Default Table (Continued)*

F Keys	Keystroke
5022	F 22
5023	F 23
5024	F 24

Table E-7 *Numeric Key Standard Default Table*

Numeric Keypad	Keystroke
6042	*
6043	+
6044	Undefined
6045	-
6046	.
6047	/
6048	0
6049	1
6050	2
6051	3
6052	4
6053	5
6054	6
6055	7
6056	8
6057	9
6058	Enter
6059	Num Lock

Table E-8 *Extended Keypad Standard Default Table*

Extended Keypad	Keystroke
7001	Break
7002	Delete
7003	Pg Up
7004	End
7005	Pg Dn
7006	Pause
7007	Scroll Lock
7008	Backspace
7009	Tab
7010	Print Screen
7011	Insert
7012	Home
7013	Enter
7014	Escape
7015	Up Arrow
7016	Dn Arrow
7017	Left Arrow
7018	Right Arrow

Index

A

ADF	
invalid rule	3-2
transmit error	2-2, 3-2
advanced data formatting	2-2, 3-2
aiming	2-4
ASCII values	
keyboard wedge	5-12
RS-232	6-17
USB	7-11
auto-scan mode	1-1, 2-3, 4-5

B

bar code defaults	
keyboard wedge	5-3
RS-232	6-3
symbolologies	8-2
USB	7-3
user preferences	4-2
bar codes	
beep after good decode	4-7
beeper tone	4-4
beeper volume	4-4
cancel	D-3
FN1 sub values	4-10
keyboard wedge	
alternate numeric keypad emulation	5-8
caps lock on	5-8
caps lock override	5-9
country keyboard types (country codes)	5-5
host types	5-4
ignore unknown characters	5-6
intra-keystroke delay	5-7
keystroke delay	5-7
laser on time	4-6

numeric bar codes	D-3
power mode	4-5
prefix/suffix values	4-8
RS-232	
baud rate	6-7
beep on	6-14
check receive errors	6-10
data bits	6-9
hardware handshaking	6-10
host serial response time-out	6-13
host types	6-6
ignore unknown characters	6-16
intercharacter delay	6-15
Nixdorf Beep/LED options	6-16
RTS line state	6-14
stop bit select	6-9
RS-232 parameters	
parity	6-8
scan data transmission format	4-8
scan line width	4-6
scanning mode	4-5
set defaults	4-3
symbolologies	
bi-directional redundancy	8-47
bookland EAN, enable/disable	8-7
bookland ISBN	8-17
Chinese 2 of 5, enable/disable	8-36
codabar CLSI editing	8-38
codabar lengths	8-37
codabar NOTIS editing	8-38
codabar, enable/disable	8-36
code 11 check digit verification	8-30
code 11 lengths	8-29
code 11, transmit check digits	8-30
code 128, enable/disable	8-18
code 39 buffering	8-24, 8-25
code 39 check digit verification	8-23

code 39 full ASCII conversion	8-24
code 39 lengths	8-22
code 39 transmit buffer	8-26
code 39 transmit check digit	8-23
code 39, enable/disable	8-20
code 93 lengths	8-27
code 93, enable/disable	8-27
convert UPC-E to UPC-A	8-15
convert UPC-E1 to UPC-A	8-16
discrete 2 of 5 lengths	8-35
discrete 2 of 5, enable/disable	8-34
EAN-13/EAN-8, enable/disable	8-7
EAN-8/JAN-8 extend	8-16
GS1 databar, convert to UPC/EAN	8-43
GS1 databar, enable/disable	8-42
GS1-128, enable/disable	8-19
I 2 of 5 check digit verification	8-33
I 2 of 5 convert to EAN-13	8-34
I 2 of 5 lengths	8-31
I 2 of 5 transmit check digit	8-33
I 2 of 5, enable/disable	8-31
intercharacter gap	8-47
ISBT 128, enable/disable	8-19
MSI check digit algorithm	8-41
MSI check digits	8-40
MSI lengths	8-39, 8-40
MSI transmit check digits	8-41
MSI, enable/disable	8-39
redundancy levels	8-44
security levels	8-46
bi-directional redundancy	8-47
supplementals	8-8
trioptic code 39, enable/disable	8-20
UCC coupon extended code	8-18
UPC/EAN/JAN supplemental redundancy	8-11
UPC-A preamble	8-13
UPC-A transmit check digit	8-12
UPC-A/UPC-E, enable/disable	8-5
UPC-E preamble	8-14
UPC-E transmit check digit	8-12
UPC-E1 preamble	8-15
UPC-E1 transmit check digit	8-13
UPC-E1, enable/disable	8-6
transmit code ID character	4-7
transmit no read message	4-10
USB	
caps lock override	7-7
country keyboard types	7-5
device type	7-4
keystroke delay	7-7
unknown characters	7-8
bar codes RS-232	
software handshaking	6-12
beeper definitions	2-2

bullets	xii
---------	-----

C

cables	
installing	1-2
interface	1-3
removing cables	1-3
character set	5-12, 6-17, 7-11
Chinese 2 of 5 bar codes	8-36
codabar bar codes	8-36
code 11 bar codes	8-28
code 128 bar codes	8-18
code 39 bar codes	8-20
code 93 bar codes	8-27
code identifiers	
AIM code IDs	B-2
Symbol code IDs	B-1
configurations	xi
conventions	
notational	xii

D

default parameters	
keyboard wedge	5-3
RS-232	6-3
symbolologies	8-2
USB	7-3
user preferences	4-2
discrete 2 of 5 bar codes	8-34
DTF bar codes	8-34

E

error indications	
ack/nak	6-12
ADF	2-2, 3-2
beeper	4-7
enq	6-12
format	2-2, 3-3
input	2-2, 3-2
laser on time	4-6
RS-232	2-2, 3-2
RS-232 transmission	6-10
symbolologies	8-2
transmission	2-2, 2-3, 3-2, 6-13
unknown characters	5-6, 6-16, 7-8
user preferences	4-2
xon/xoff	6-12

G

GS1 databar bar codes	
-----------------------	--

- reduced space symbology 8-42
- H**
- host types
 - keyboard wedge 5-4
 - RS-232 6-6
 - USB 7-4
- I**
- information, service xiii
 - intercharacter gap 8-47
 - interleaved 2 of 5 bar codes 8-31
- K**
- keyboard wedge connection 5-2
 - keyboard wedge defaults 5-3
 - keyboard wedge parameters 5-4
- L**
- LED definitions 2-3
- M**
- maintenance 3-1
 - MSI bar codes 8-39
- N**
- notational conventions xii
 - NW - 7 8-36
- P**
- parameter defaults
 - keyboard wedge 5-3
 - RS-232 6-3
 - symbologies 8-2
 - USB 7-3
 - user preferences 4-2
 - parameters
 - beep after good decode 4-7
 - beeper tone 4-4
 - beeper volume 4-4
 - FN1 sub values 4-10
 - keyboard wedge 5-4
 - laser on time 4-6
 - power mode 4-5
 - prefix/suffix values 4-8
 - RS-232 6-4
 - scan data transmission format 4-8
 - scan line width 4-6
 - scanning mode 4-5
 - set defaults 4-3
 - symbologies 8-2
 - transmit code ID character 4-7
 - transmit no read message 4-10
 - USB 7-4
 - parts 2-1, 2-4
 - pinouts
 - scanner signal descriptions 3-6
 - power supply
 - connecting 1-3
- R**
- RS-232 connection 6-2
 - RS-232 defaults 6-3
 - RS-232 parameters 6-4
- S**
- sample bar codes
 - code 128 C-2
 - code 39 C-1
 - GS1 databar C-3
 - interleaved 2 of 5 C-2
 - UPC/EAN C-1
 - scanner parts 2-1, 2-4
 - scanning
 - aiming 2-4
 - auto-scan mode 2-3
 - errors 5-6, 7-8
 - symbologies sequence example 8-1
 - triggered mode 2-3
 - user preferences sequence example 4-1
 - security level bar codes
 - bi-directional redundancy 8-47
 - security levels 8-44, 8-46
 - service information xiii
 - setup
 - connecting a USB interface 7-2
 - connecting an RS-232 interface 6-2
 - connecting interface cable 1-3
 - connecting keyboard wedge interface 5-2
 - connecting power 1-3
 - installing the cable 1-2
 - unpacking 1-2
 - signal descriptions 3-6
 - specifications 3-5
 - symbologies defaults 8-2
- T**
- technical specifications 3-5

triggered mode 1-1, 2-3, 4-5
troubleshooting 3-2

U

unpacking 1-2
UPC/EAN bar codes 8-5
USB connection 7-2
USB defaults 7-3
USB parameters 7-4
user preferences bar codes
 beep after good decode 4-7
 beeper tone 4-4
 beeper volume 4-4
 FN1 sub values 4-10
 laser on time 4-6
 power mode 4-5
 prefix/suffix values 4-8
 scan data transmission format 4-8
 scan line width 4-6
 scanning mode 4-5
 set defaults 4-3
 transmit code ID character 4-7
 transmit no read message 4-10
user preferences defaults 4-2



Zebra Technologies Corporation
Lincolnshire, IL U.S.A.
<http://www.zebra.com>

© 2018 ZIH Corp and/or its affiliates. All rights reserved. ZEBRA and the stylized Zebra head are trademarks of ZIH Corp, registered in many jurisdictions worldwide. All other trademarks are the property of their respective owners.